

* All rights reserved
* Print Jan,2023.

KIN LONG
For Better Living

Steel Wire Mesh Accessory Catalogue

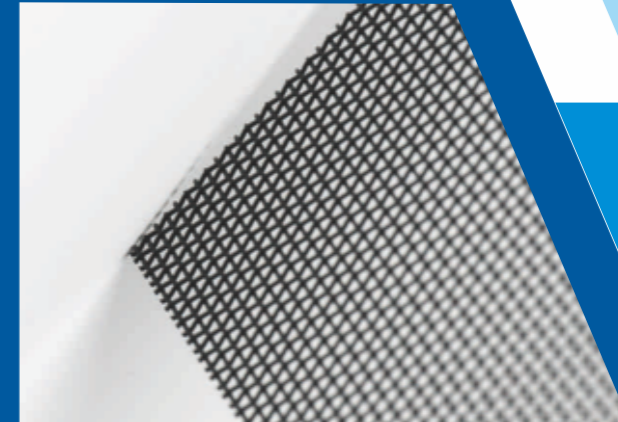
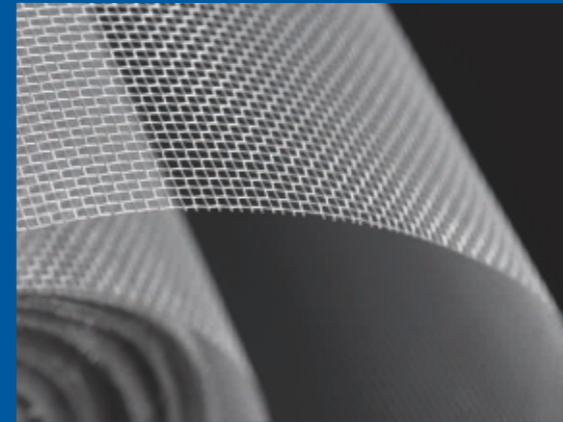
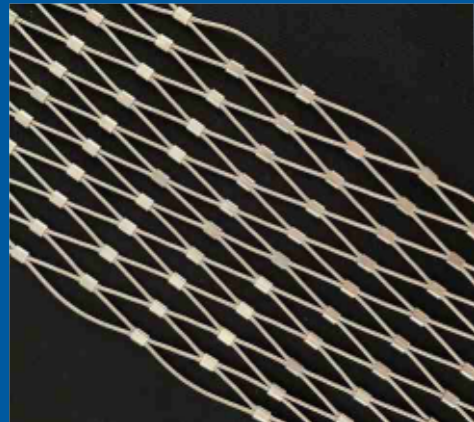

Guangdong Kinlong Hardware Products Co., Ltd.

No.3, Jian Lang Rd., Tangxia Town, Dongguan City, china.

T : 0086-769-82166666 82136666

F : 0086-769-82955240 82955241

E : mail@kinlong.com

H : www.kinlong.com

www.kinlong.com

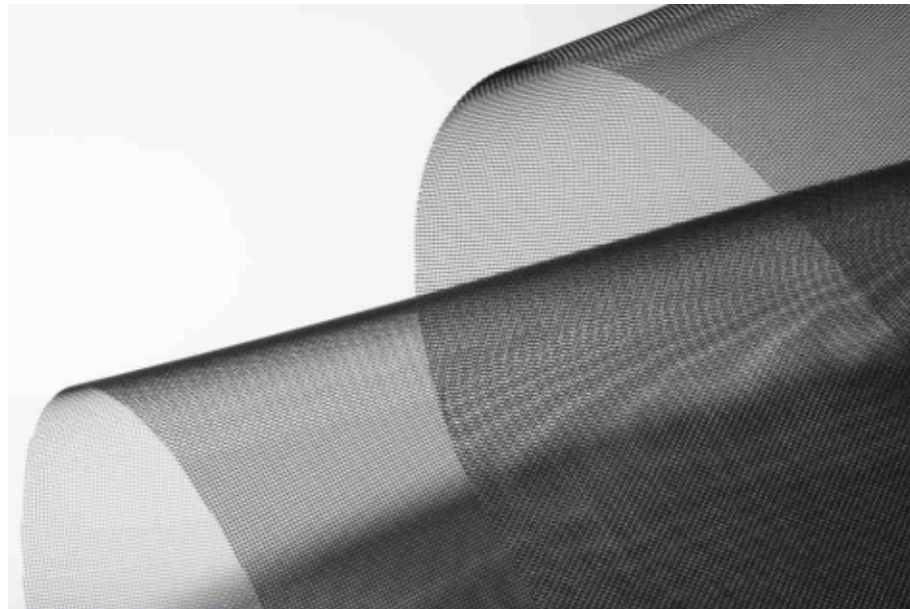

Product Catalog

A	Steel Mesh Series	
	• Security mesh 304/316	03/04
	• Electro-Circulation Magnetic steel mesh	05/06
	• Aerometal mesh	07/08
B	Invisible Gauze Mesh Series	
	• GT gauze mesh	11/12
	• Anti-haze gauze mesh	13/14
	• Fiberglass gauze mesh	15/16
	• Micron gauze mesh	17/18
	• Folding guaze mesh	19/20
C	Protective decorative mesh series	
	• Stainless steel rope mesh	23/26
	• Curtain decorative mesh	27/30
	• Spiral mesh	31/32
	• Curtain mesh	33/34
	• Stretched mesh	35/38
	• Welding mesh	39/40
• Otherprotective mesh	41/42	



Security Screen Window Mesh Series

Safety with anti-theft
environmental protection and health

- Security mesh 304 / 316
- Electro-Circulation magnetic steel mesh
- Aerometal mesh



Security Mesh 304 /316

National standard 304/316 stainless steel, 7 items passed the testing



Security Mesh 304/316

Safety with anti-theft, environmental protection and health

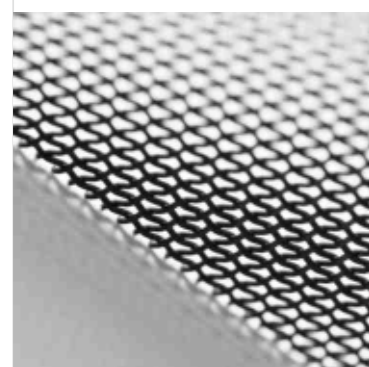

Product Parameters

Product name	Security mesh 304/316
Brand name	KIN LONG
Product material	S.S.304 / 316
Weaving method	Plain weave
Wire diameter	0.5mm(13items) 0.6mm(13items) 0.7mm(12items) 0.8mm(11items) 0.9mm(10items) 1.0mm(10items)
Color	Black/grey/Natural
Width (m)	0.8m/0.9m/1.0m/1.1m/1.2m/1.3m/1.5m
Length (m)	2.4m / 31.5m
Packing	Wood box for free fumigation

Security Mesh 304 /316

National standard 304/316 stainless steel, 7 items passed the testing

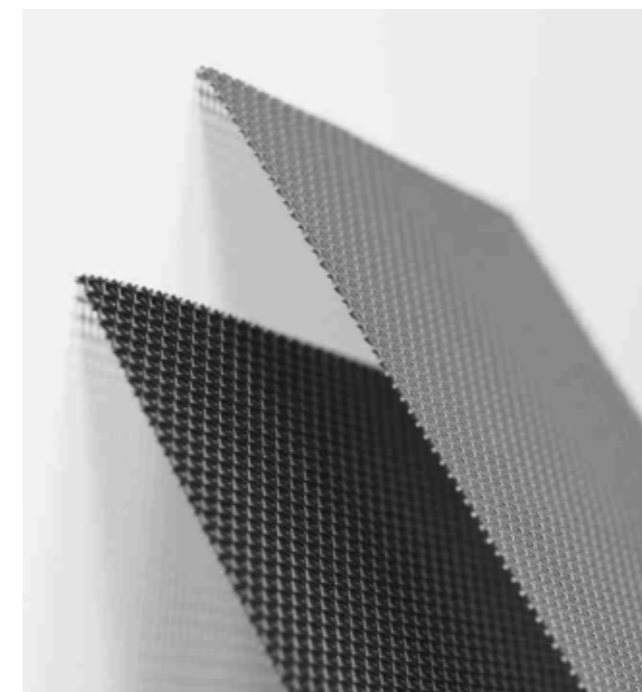
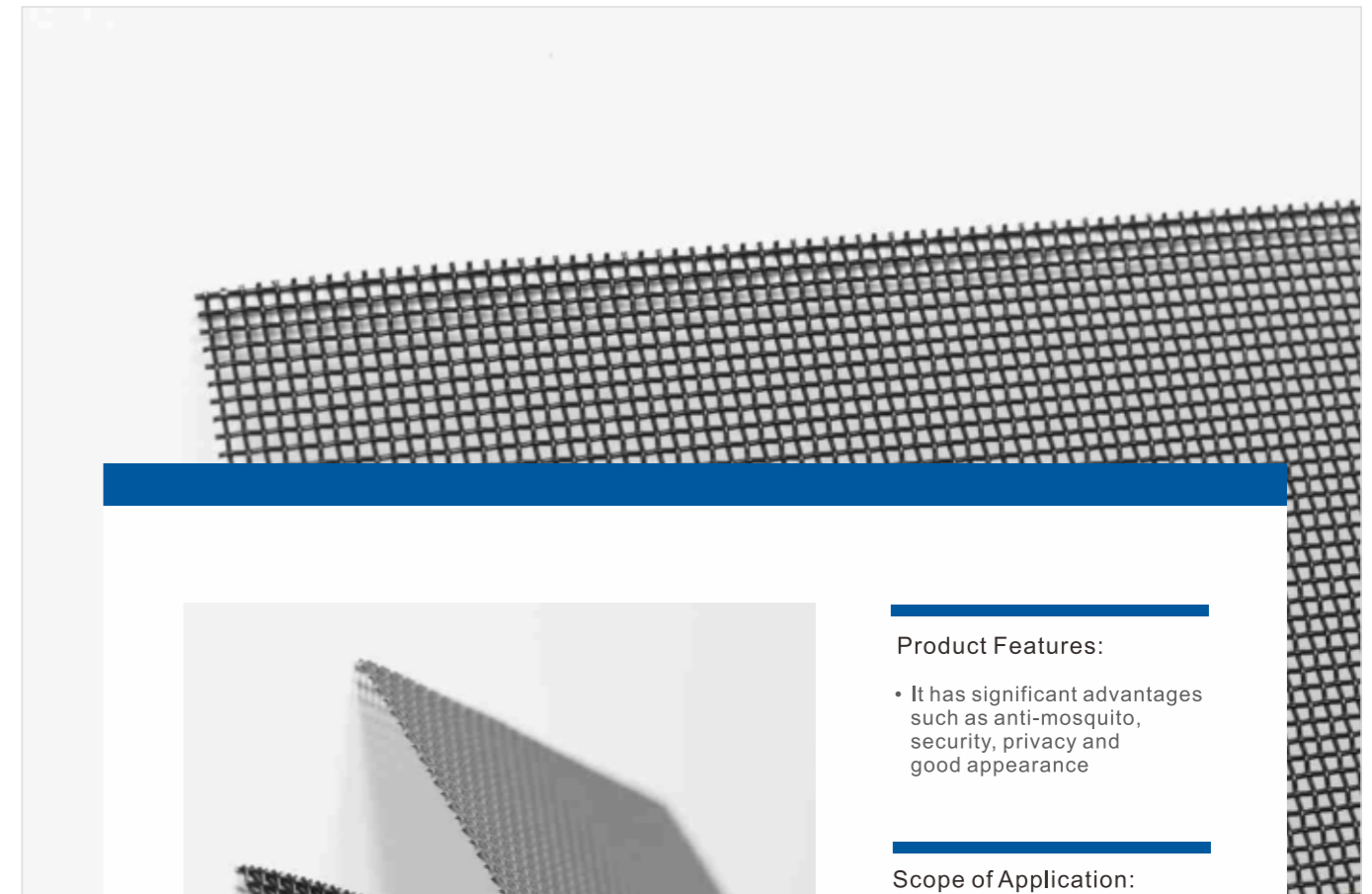

Product Features:

- It has significant advantages such as anti-mosquito, security, privacy and good appearance

Scope of Application:

- Security screen window
- Gauze mesh door
- Industrial protection
- Residential villas
- Decorative arts and crafts

Electro-Circulation Magnetic Steel Mesh

Diamond mesh series shows unprecedented HD vision, transparency, black&shiny texture

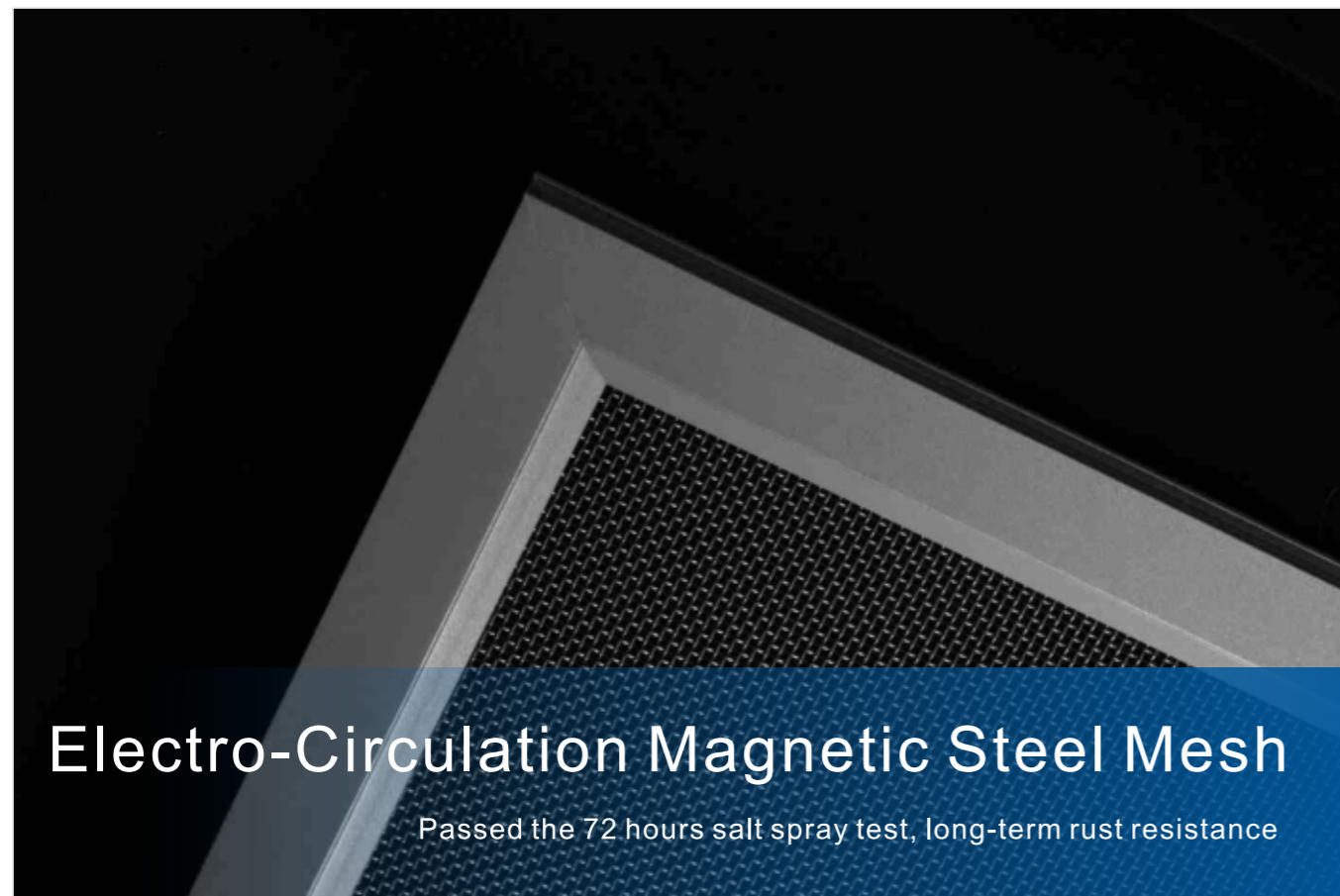

Electro-Circulation Magnetic Steel Mesh

Passed the 72 hours salt spray test, long-term rust resistance

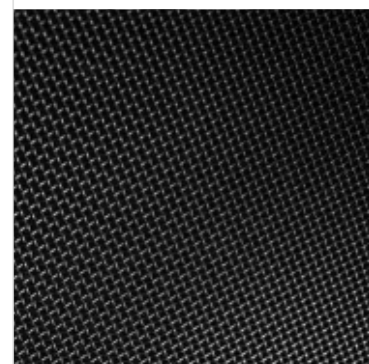

Product Parameters

Product name	Electro-Circulation Magnetic steel mesh
Brand name	KIN LONG
Product materia	S.S.304
Weaving craft	Plain weave
Surface finish	Elctric cycle magnetic technology immersion coloring
Wire diameter	0.8mm
Mesh number	11 mesh
Color	Black
Width (m)	0.8m/0.9m/1.0m/1.1m/1.2m
Length (m)	2.4m
Packing	Wood box for free fumigation

Electro-Circulation Magnetic Steel Mesh

Diamond mesh series shows unprecedented HD vision, transparency, black&shiny texture

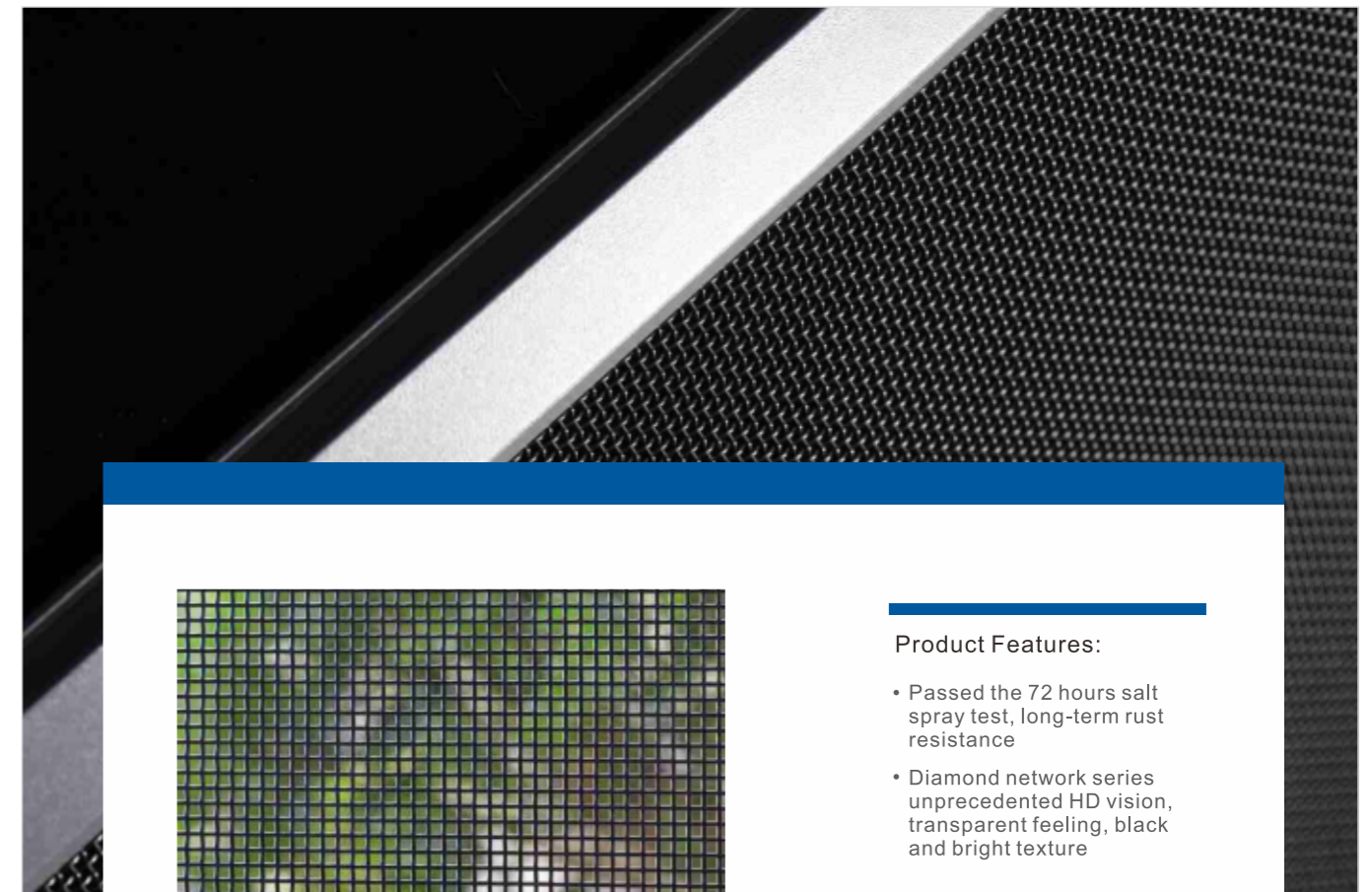

• Washable and easy to clear



• Good invisibility

Product Features:

- Passed the 72 hours salt spray test, long-term rust resistance
- Diamond network series unprecedented HD vision, transparent feeling, black and bright texture

Scope of Application:

- Security screen window
- Screen door

Aerometal Mesh

The anti-oxidation function makes life span of mesh as 13 years.

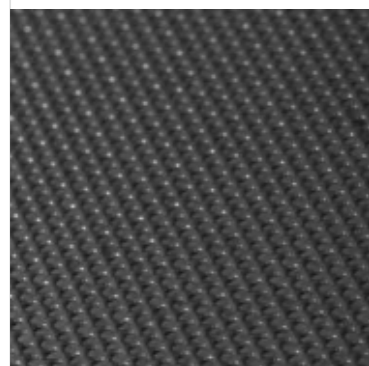
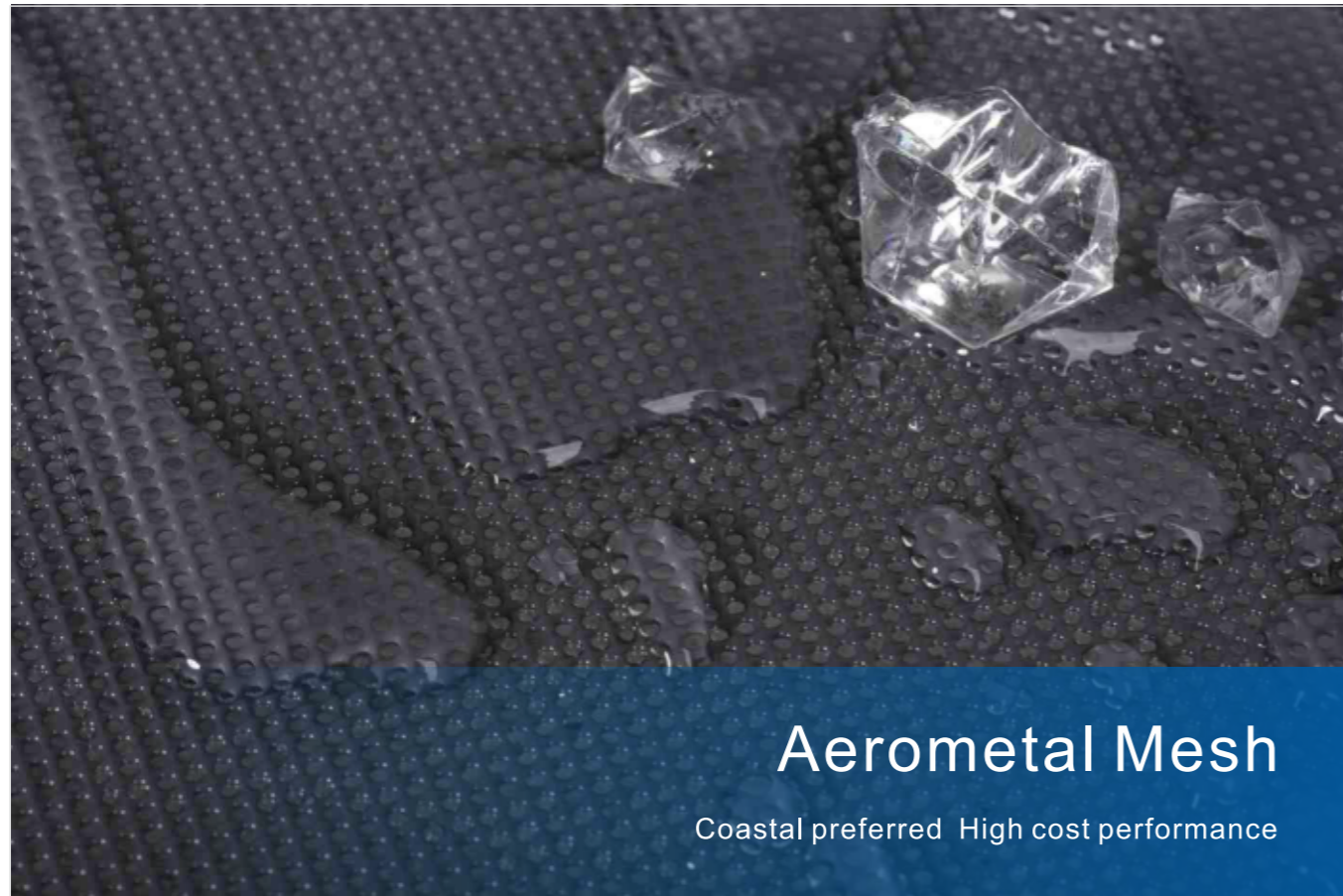

Product Parameters

Product name	Aerometal mesh
Brand name	KIN LONG
Product material	Aviation grade aluminum alloy
Weaving craft	Plain weave
Wire diameter	0.6mm / 0.8mm
Color	Black/grey/silvery/light grey
Width (m)	0.8m/0.9m/1.0m/1.1m/1.2m/1.3m/1.5m
Length (m)	31.5m
Packing	Wood box for free fumigation

Aerometal Mesh

The anti-oxidation function makes life span of mesh as 13 years.

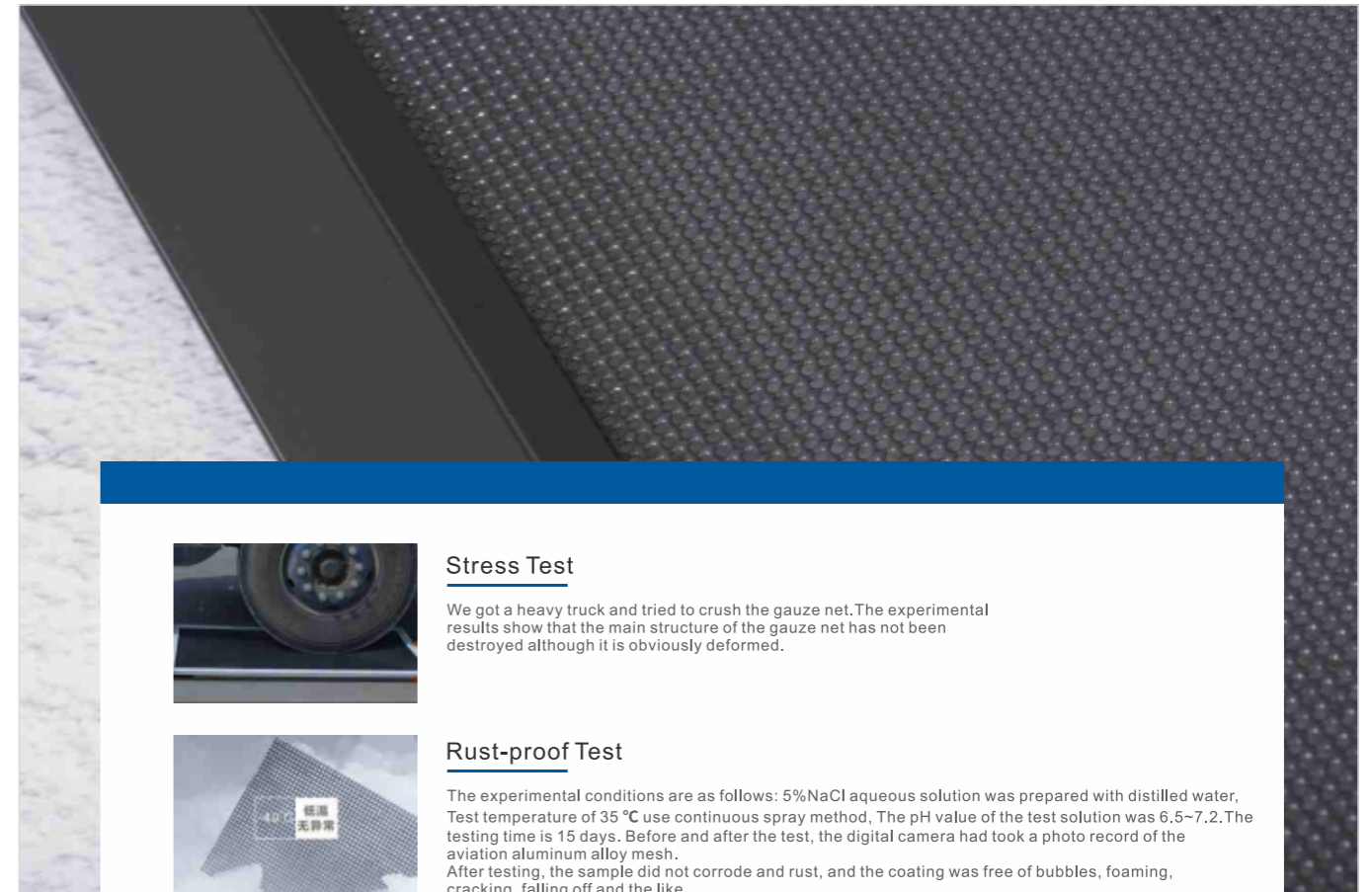

Stress Test

We got a heavy truck and tried to crush the gauze net. The experimental results show that the main structure of the gauze net has not been destroyed although it is obviously deformed.

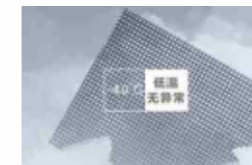

Rust-proof Test

The experimental conditions are as follows: 5%NaCl aqueous solution was prepared with distilled water, Test temperature of 35 °C use continuous spray method, The pH value of the test solution was 6.5~7.2. The testing time is 15 days. Before and after the test, the digital camera had taken a photo record of the aviation aluminum alloy mesh. After testing, the sample did not corrode and rust, and the coating was free of bubbles, foaming, cracking, falling off and the like.



High Temperature Test

We have prepared for this high temperature boiling test, put the net in boiling water at 100 °C, There is no abnormal change or deformation of the product in long-term high temperature state.

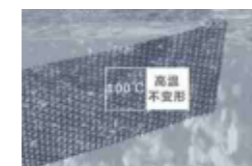

Low Temperature Test

40°C below zero surface coating is not cracking, No brittle fracture for internal wire.



Anti Oxidation Test

We got some fresh fruits and vegetables and put them with the mesh. Through observation we can learn that the fruit gradually oxidation rot, gauze net surface has no obvious signs of oxidation.

B

Invisible Gauzemes series

Anti - mosquito and insect
Environmental protection for better health
Good invisibility

- GT gauze mesh
- Anti-haze gauze mesh
- Fiberglass gauze mesh
- Micron gauze mesh
- Folding guaze mesh



GT Gauze Mesh(window screen)304/316

High - grade invisible window screen



GT Gauze Mesh

Light filtering technology,
effectively resist uv, for high - grade invisible window screen

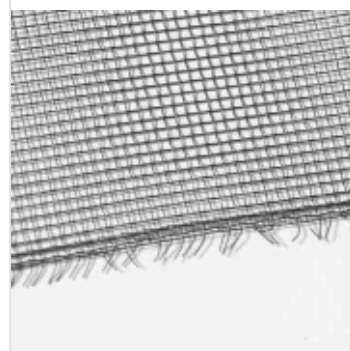

Product Parameters

Product name	GT gauze mesh(window screen)304/316
Brand name	KIN LONG
Product materia	304/316
Wire diameter	0.18mm(18items) 0.22mm(20items) 0.3mm(18items/20items)
Color	Black
Width (m)	0.6m/0.7m/0.8m/0.9m/1.0m/1.2m/1.5m
Length (m)	30m
Packing	Export special fumigation-free wooden box

GT Gauze Mesh(window screen)304/316

High - grade invisible window screen

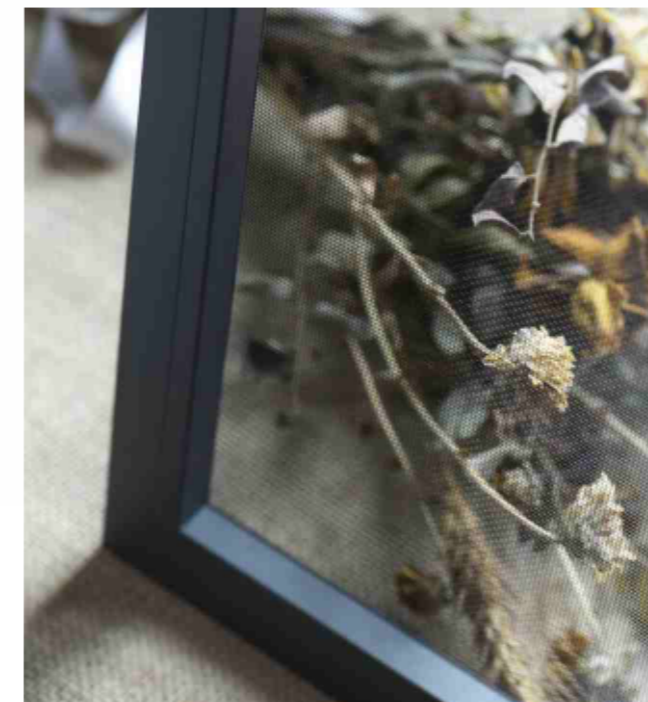
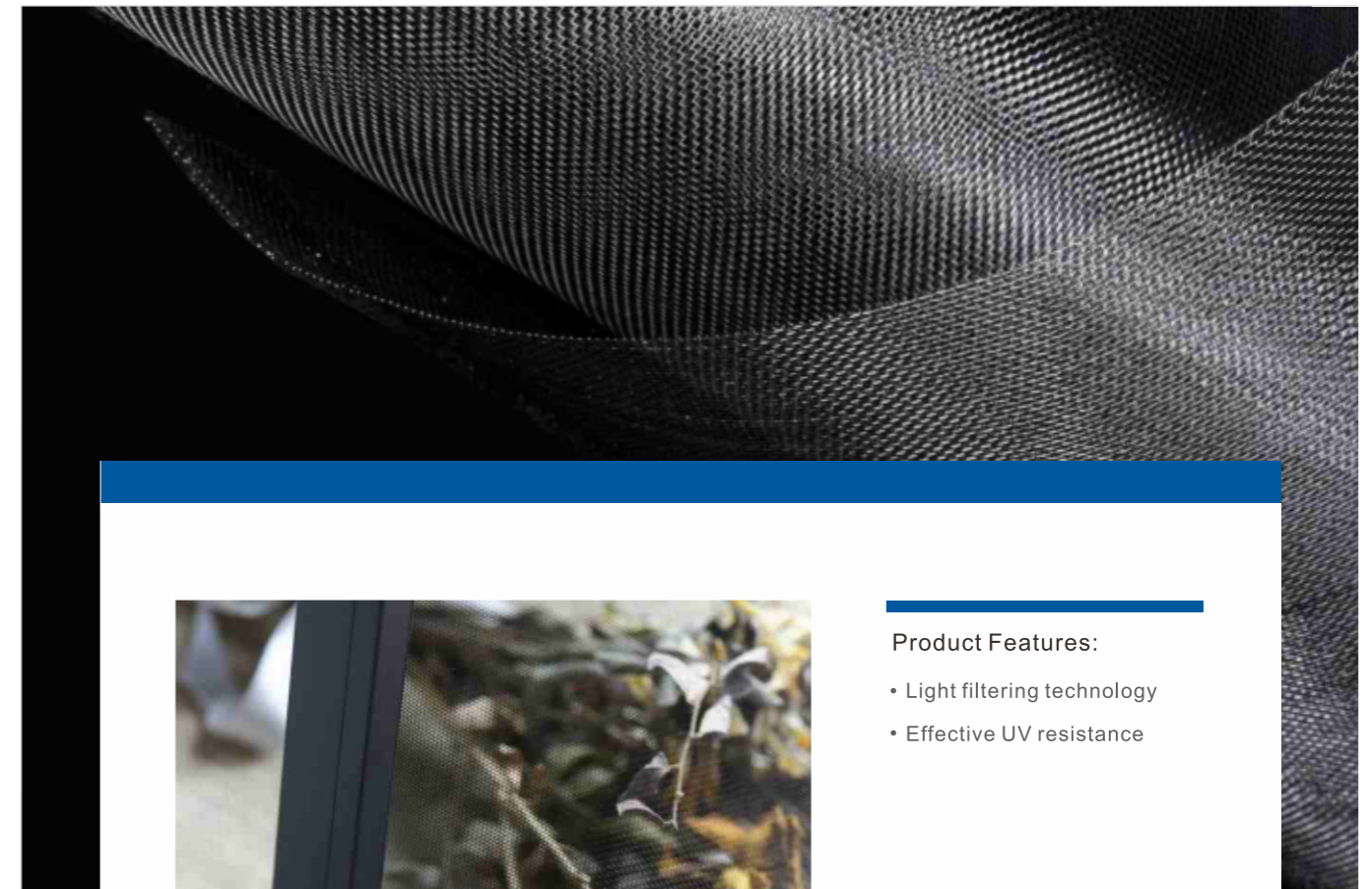

Product Features:

- Light filtering technology
- Effective UV resistance

Scope of Application:

- Anti-mosquito and Insect-proof screen window
- Invisible window screen
- Handicraft
- Fashion decoration

Anti-haze Gauze Mesh

The real enemy is invisible dust.



Anti-haze Gauze Mesh

Multiple protection dust and water proof



Product Parameters

Product name	Anti-haze gauze mesh
Brand name	KIN LONG
Product material	Japan imports polyester
Color	Black
Width (m)	1.0m/1.2m/1.5m
Length (m)	50m

Anti-haze Gauze Mesh

The real enemy is invisible dust.

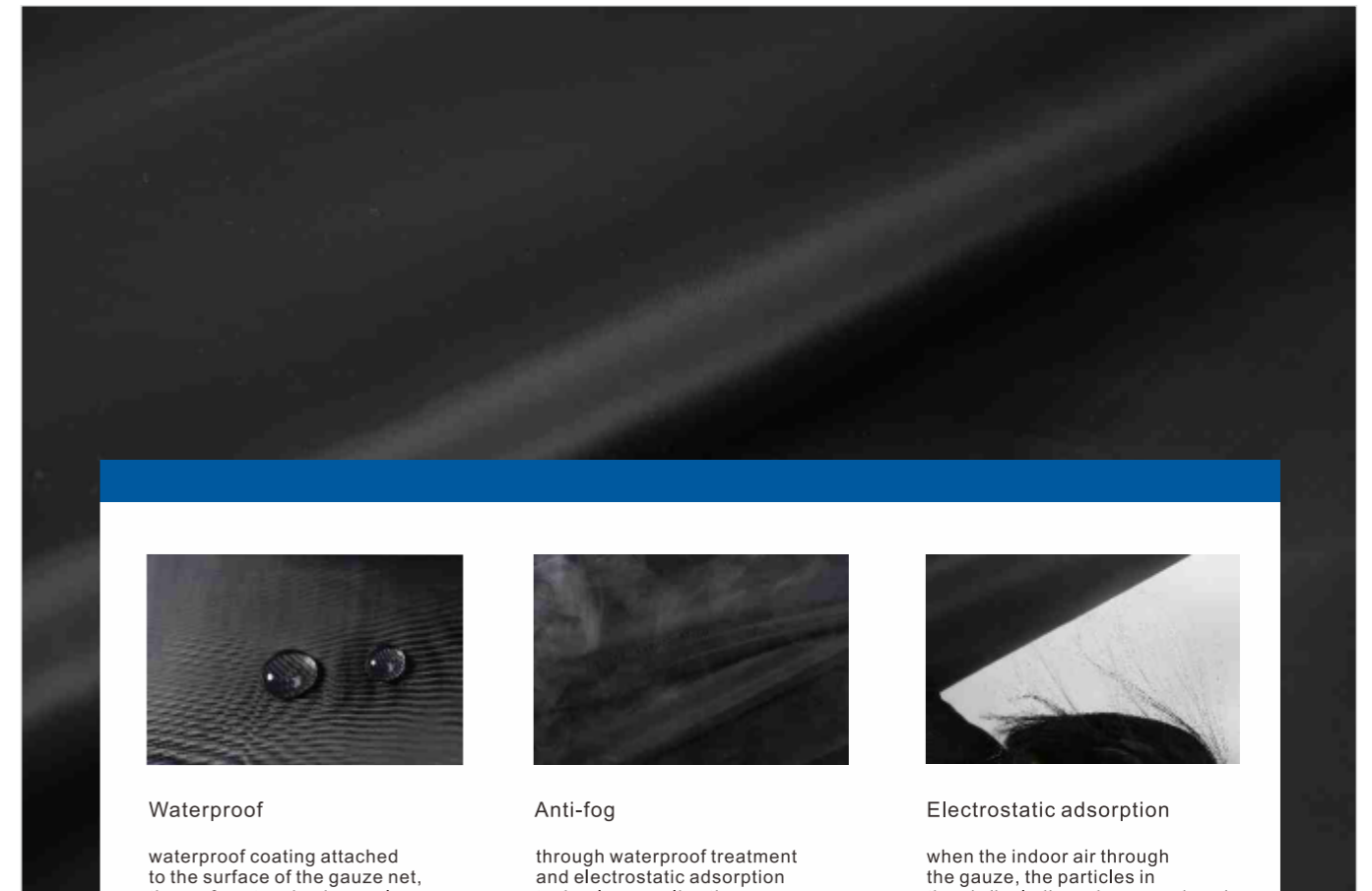

Waterproof

waterproof coating attached to the surface of the gauze net, the surface tension is very low; Increase the hydrophobic, oil drainage, anti-fouling and others properties of the surface of the gauze



Anti-fog

through waterproof treatment and electrostatic adsorption technology, realize the evacuation of rainwater from gauze net and block the haze to achieve the filtering function



Electrostatic adsorption

when the indoor air through the gauze, the particles in the air (including microorganisms) with positive charge is adsorbed to the sand net



Product Features:

- Regular washing with water can be clean as new
- The affinity of the profile is very high, most of window screen on the market can be replaced by this gauze

Scope of Application:

- Anti-mosquito and
- Insect-proof screen window
- Invisible screen window
- Outdoor tent

Fiberglass Gauze Mesh

Excellent flame retardant function , this is a big advantage that is loved by customers at home and abroad.

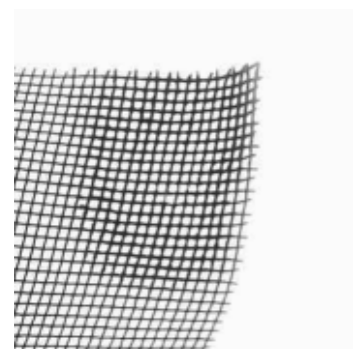

After burning
Fire will not damage the fiberglass wire

Product Parameters

Product name	Fiberglass gauze mesh
Brand name	KIN LONG
Product material	Glass fiber + PVC resin
Mesh number/g weight	
General Customization	15*17 (105gsm) /16*18 (120gsm) /20*20 (130gsm) 22*22 (145gsm) /25*25 (165gsm)
Color	Grey/black/white/greyish white/brown/green/blue
Width (m)	0.6~3.0/1.96ft~9.84ft
Length (m)	30m/100m/300m/100ft/300ft

Fiberglass Gauze Mesh

Excellent flame retardant function , this is a big advantage that is loved by customers at home and abroad.

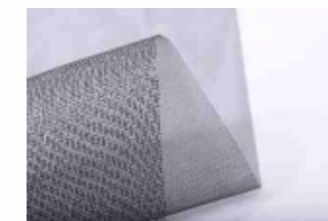
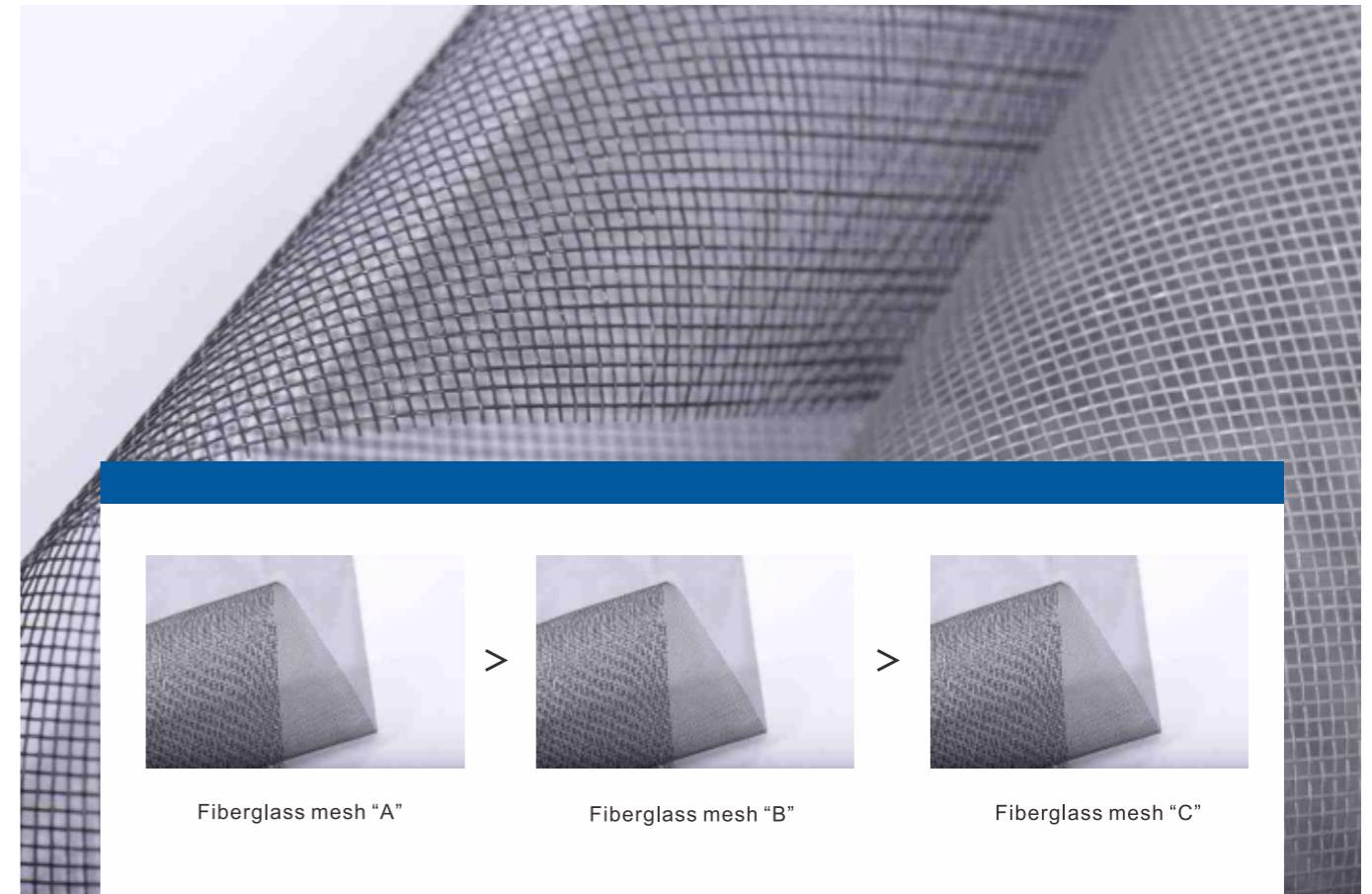

Fiberglass mesh "A"

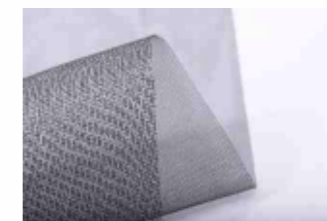

Fiberglass mesh "B"

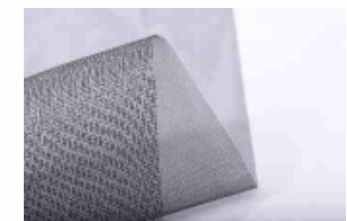

Fiberglass mesh "C"

► Performance comparison

- Fire retardant
- Service life
- Flame retardant performance
- The product smells

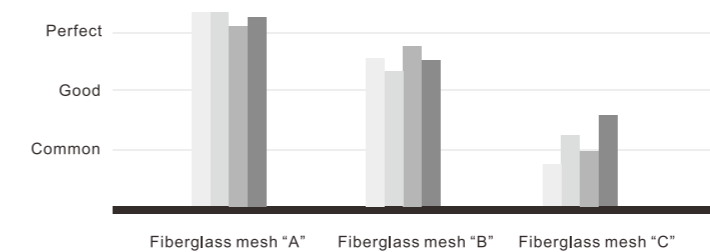

Product Features:

- Fire retardant
- Flame retardant is superior
- Long service life
- No harmful pollution
- No volatile odor
- Contains anti-uv ingredients

Scope of Application:

- Anti-mosquito and Insect-proof screen window
- Invisible screen window
- Outdoor tent

Micron Gauze Mesh

A gauze that is not easily stained with dust



Micron Gauze Mesh

The material conforms to the European Union heavy metal environmental protection standard (RoHs 2011/65/ EU environmental protection directive)

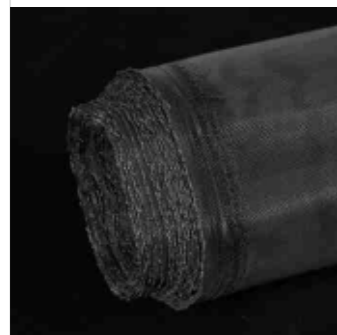

Product Parameters

Product name	Micron gauze mesh
Brand Name	KIN LONG
Product material	Polyester (imported from Japan)
Color	Black
Width (m)	1.4m / 1.6m
Length (m)	30m / 90m

Micron Gauze Mesh

A gauze that is not easily stained with dust

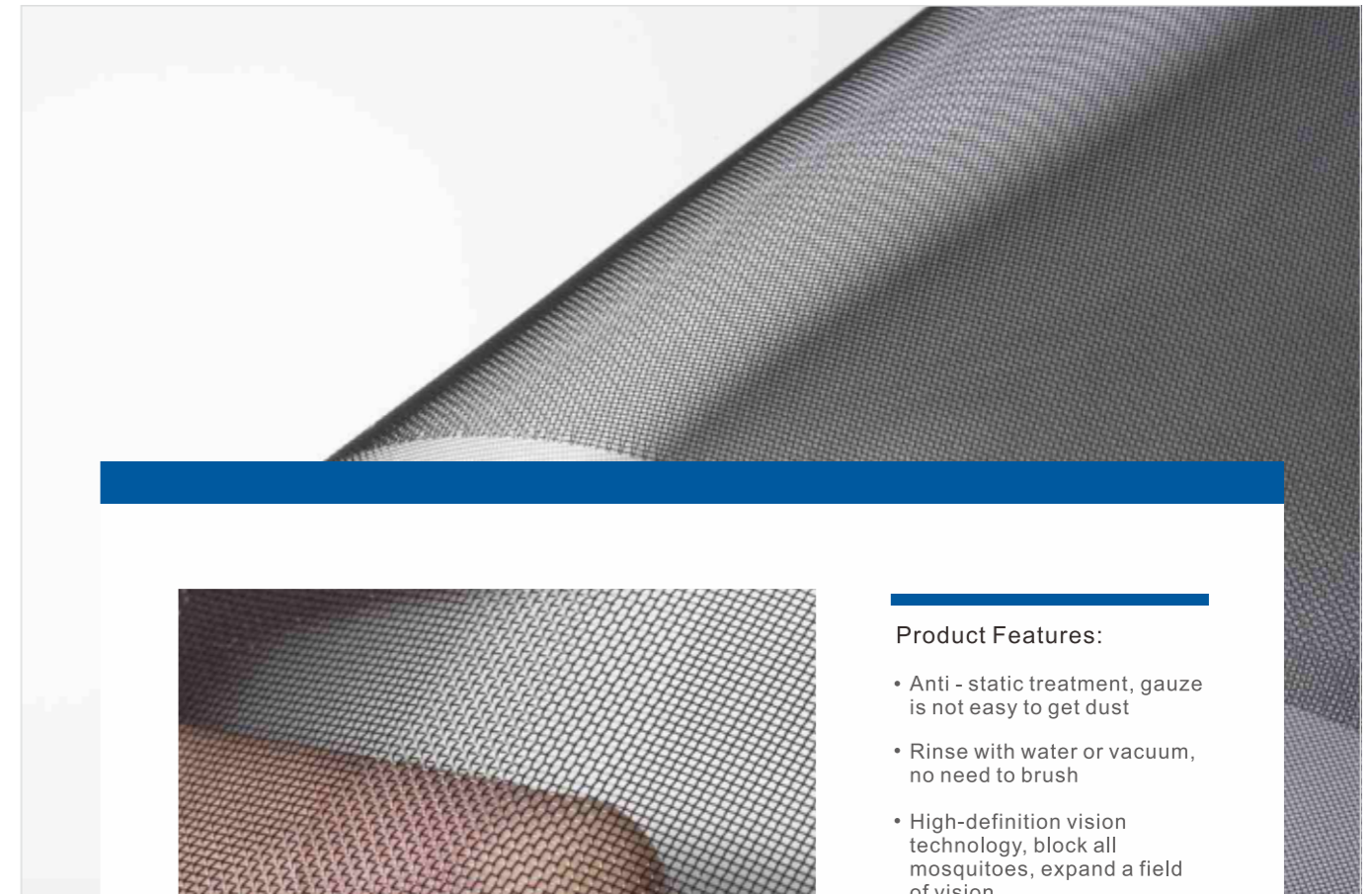

Product Features:

- Anti - static treatment, gauze is not easy to get dust
- Rinse with water or vacuum, no need to brush
- High-definition vision technology, block all mosquitoes, expand a field of vision

Scope of Application:

- Anti-mosquito and insect-proof screen window
- New Zealand Argentina Australia ranch
- Fashion decoration

Folding Gauze Mesh

Good elasticity, long life span, waterproof and dustproof



Folding Gauze Mesh

Passed the EU environmental heavy metal test
(RoHs 2011/65/EU environmental directive)

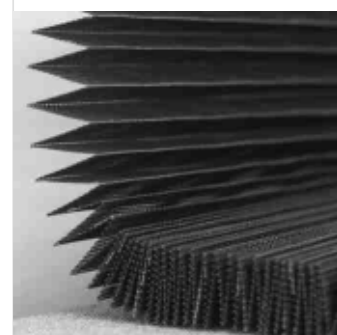

Product Parameters

Product name	Folding guaze mesh
Brand name	KIN LONG
Product material	Polyester(waterproof)
Mesh number	16 mesh
Color	Black/grey
Folding width (mm)	15mm/16mm/18mm/20mm
Wide in width (m)	2.0m/2.2m/2.4m/2.6m/3.0m (can be customized)
Length (m)	30m
Package	Export special fumigation-free wooden box

Folding Guaze Mesh

Good elasticity, long life span, waterproof and dustproof

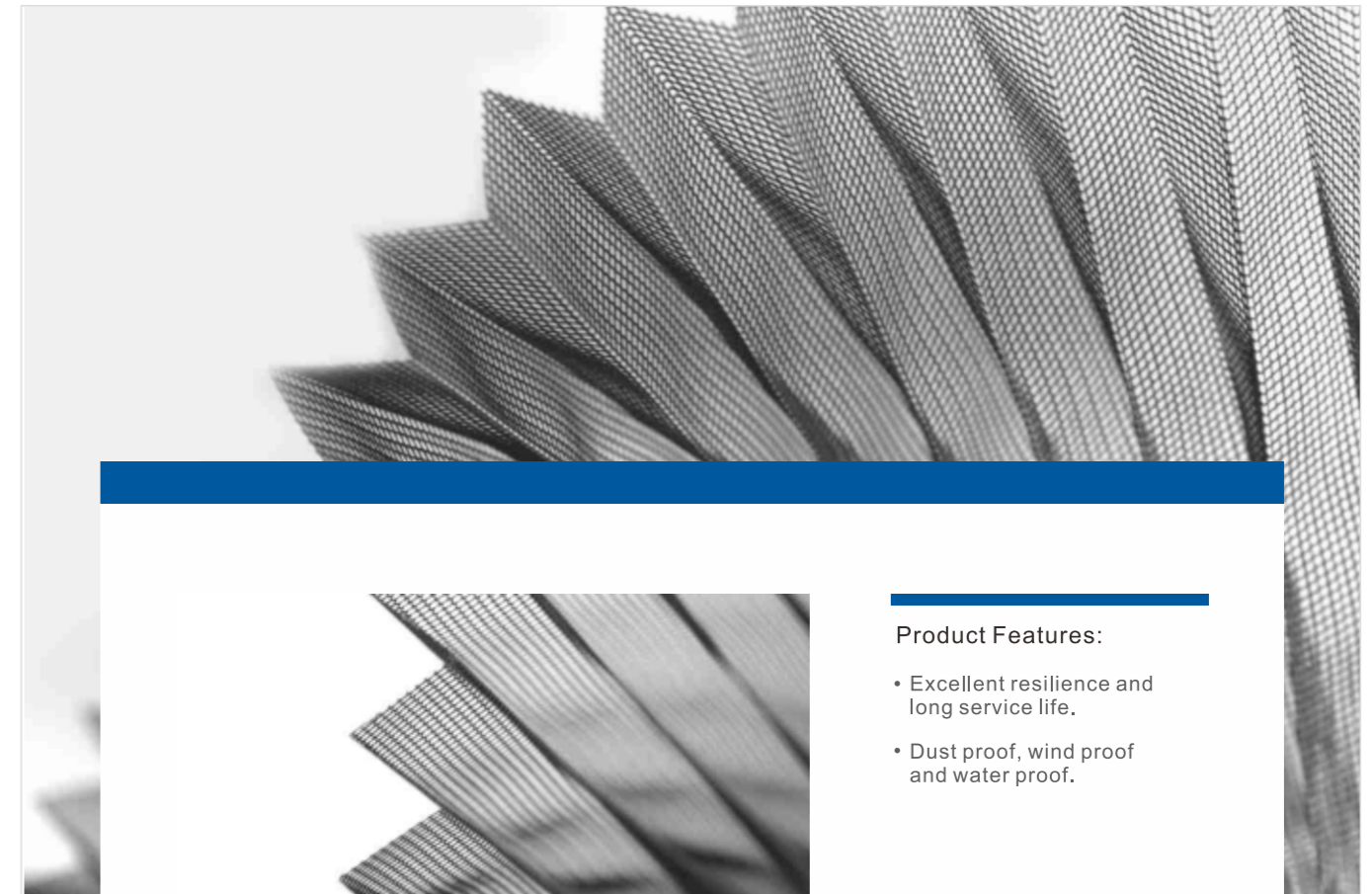

Product Features:

- Excellent resilience and long service life.
- Dust proof, wind proof and water proof.

Scope of Application:

- Anti-mosquito and insect-proof window screen
- Invisible window screen
- Wind and dust-proof window



Protective decorative mesh series

Sturdy structure, beautiful design
Simple and generous, diverse styles
Wide application, support customization

- **Stainless steel rope mesh**
- **Curtain decorative mesh**
- **Spiral mesh**
- **Curtain mesh**
- **Stretched mesh**
- **Welding mesh**
- **Other protective mesh**



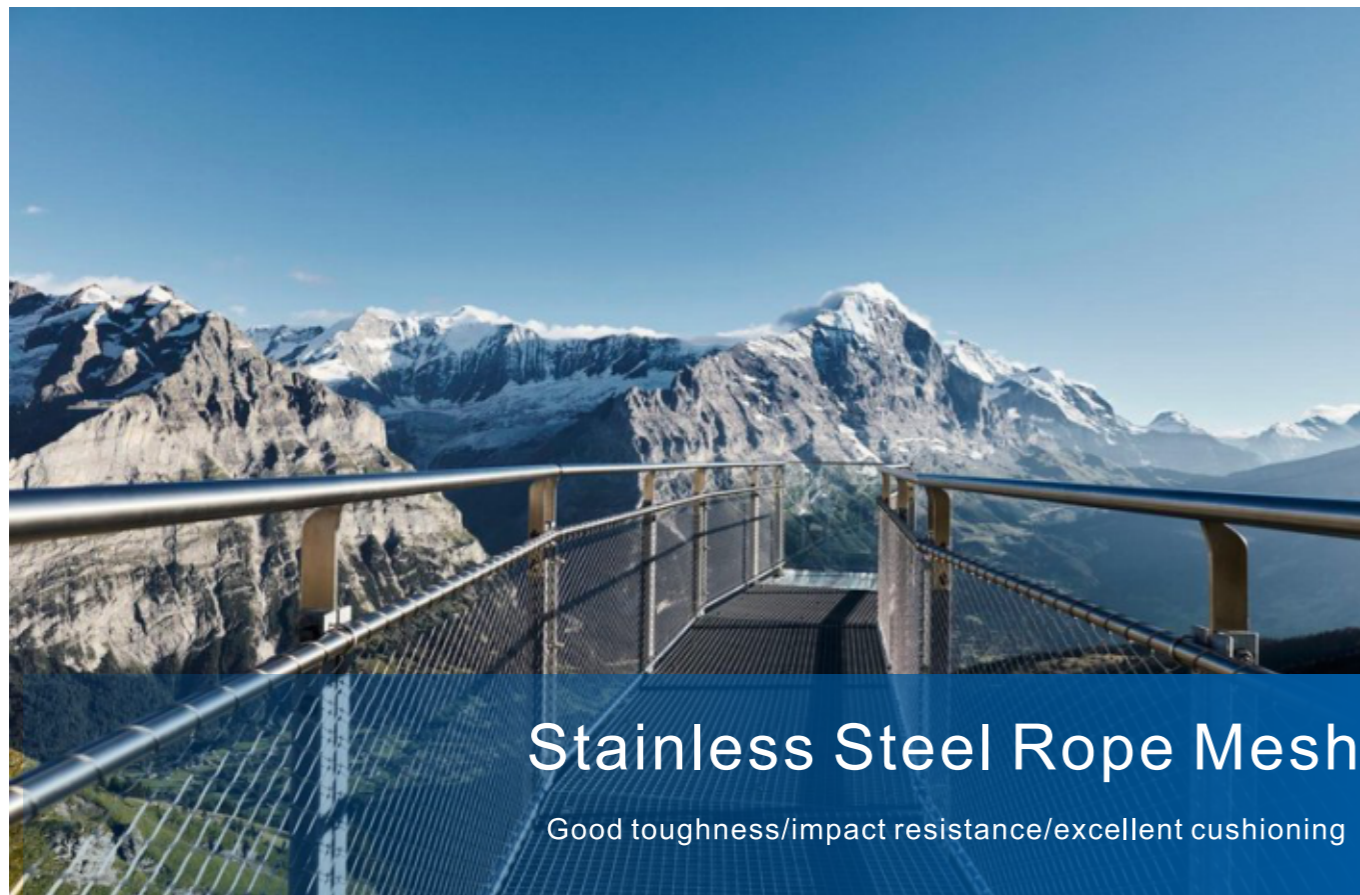

Stainless Steel Rope Mesh

Good toughness/impact resistance/excellent cushioning

Product Parameters

Product Name: Stainless steel rope mesh Commonly used wire diameter: 1.0/1.5/2.0/2.5mm (Can be customized)
 Brand Name: KIN LONG Mesh: 40*75mm/60*106mm (Can be customized)
 Product material: 304/316 Surface treatment: natural color

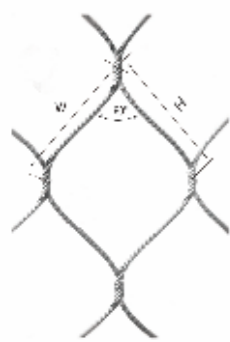

90°=standard mesh t Angle
 W =mesh width
 H =mesh width

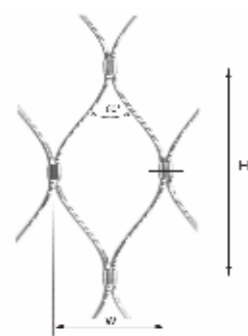

60°=Standard mesh Angle
 W = Mesh width
 H = Mesh length

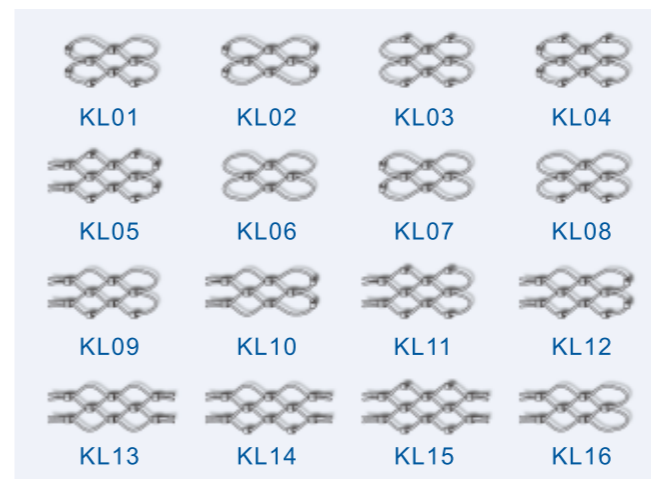

Mesh form one

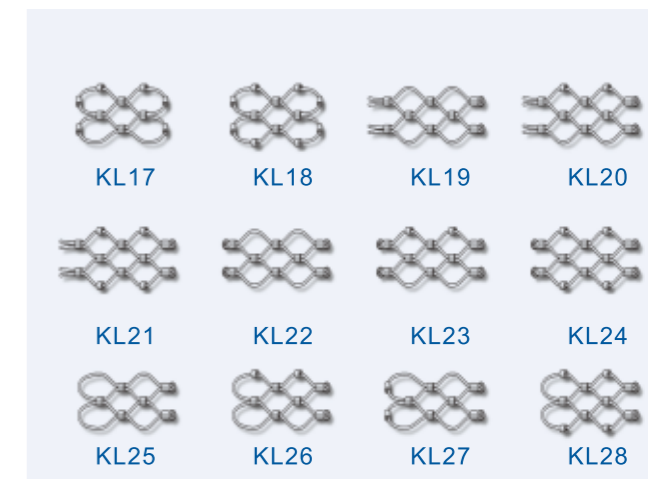

Mesh form two

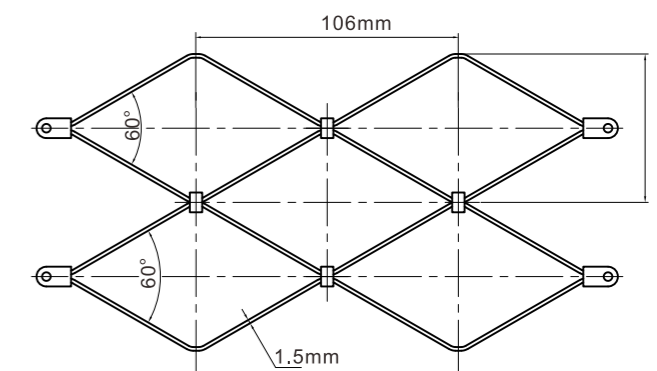

The material:304/316 The wire diameter: 1.5mm Mesh size:60*106mm Mesh sheet form: KL24

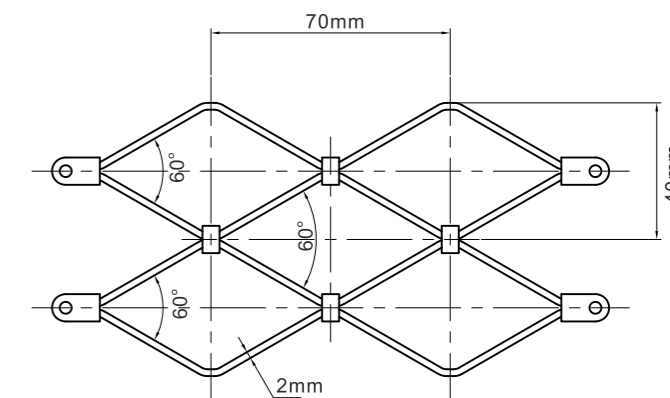
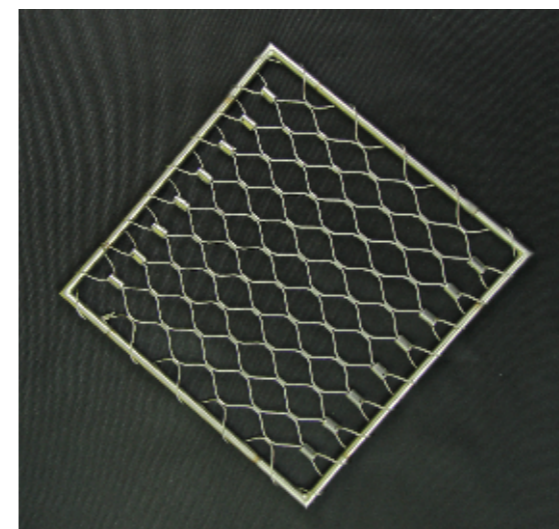

The material:304/316 The wire diameter: 2.0mm Mesh size:40*70mm Mesh sheet form: KL24

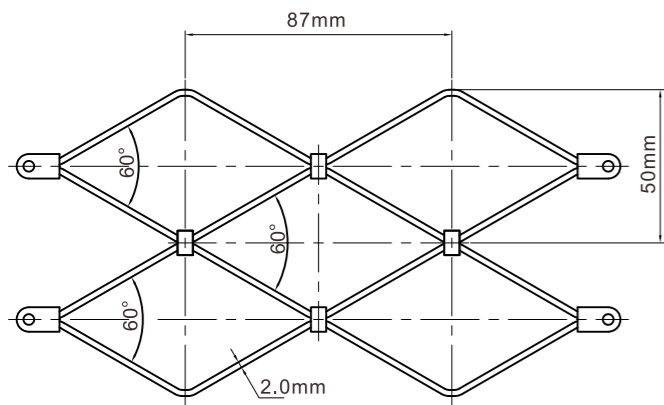

The material:304/316 The wire diameter:2.0mm Mesh size:50*87mm Mesh sheet form:KL24

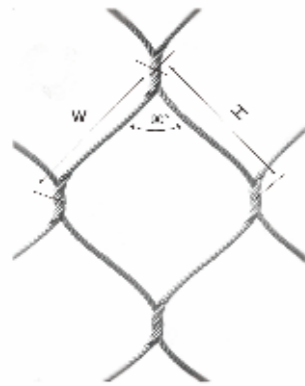

The material:304/316 The wire diameter:2.0mm Mesh width(W=H):60mm

Installation Suggestions - Tools

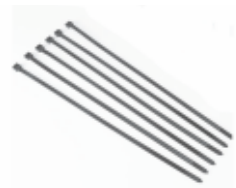

Cable tie



Pliers



Stainless steel wire rope

Wire mesh installation process diagram

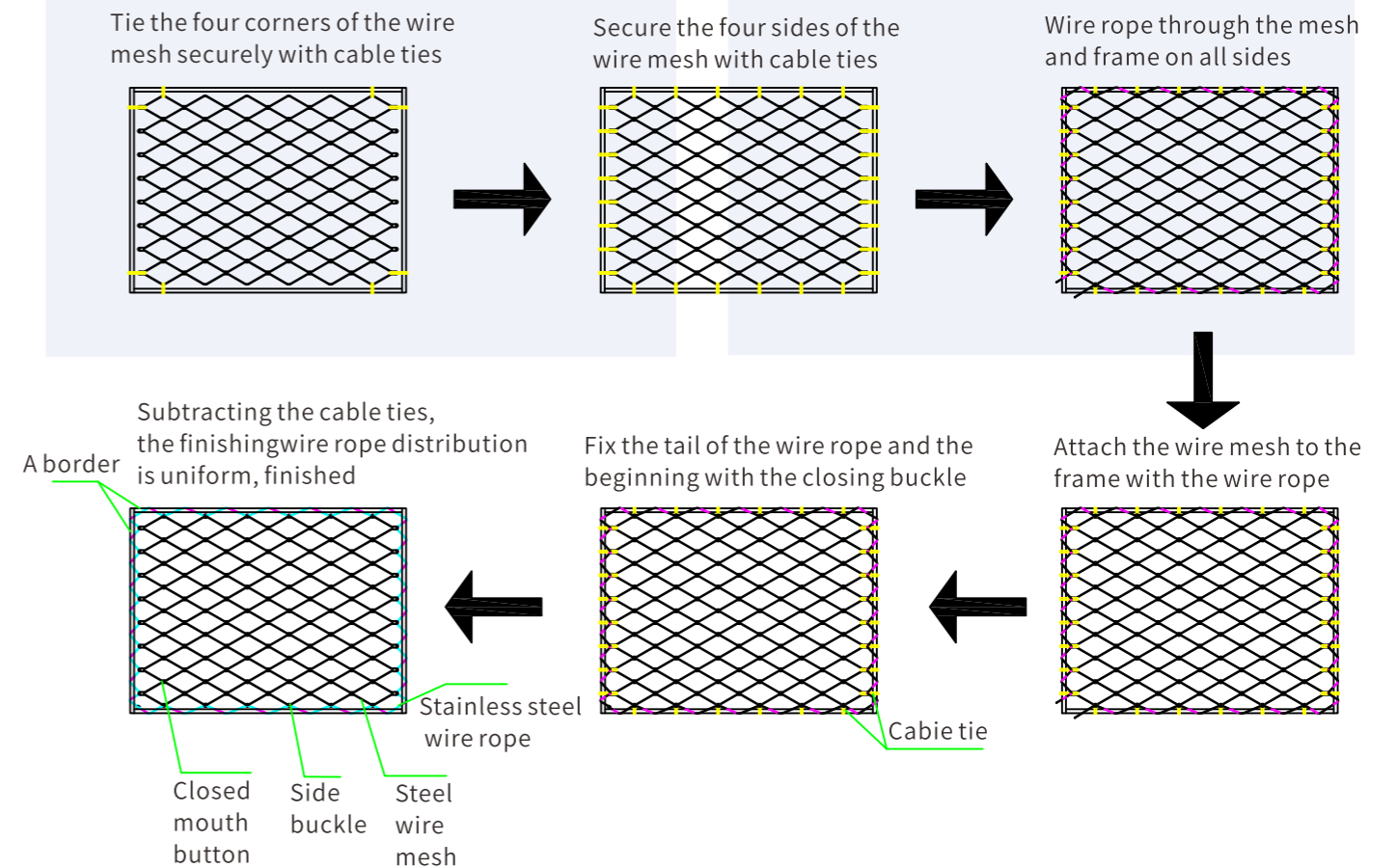

Product Features

- The net surface is smooth, the lines are beautiful, the overall structure is strong
- Good toughness, impact resistance, no deformation
- Easy to install, transparent durable, widely used

Scope of use

- Guardrail protection engineering supporting
- Curtain wall decoration/plant climbing
- Zoo partition enclosure/enclosure
- Garden protection construction

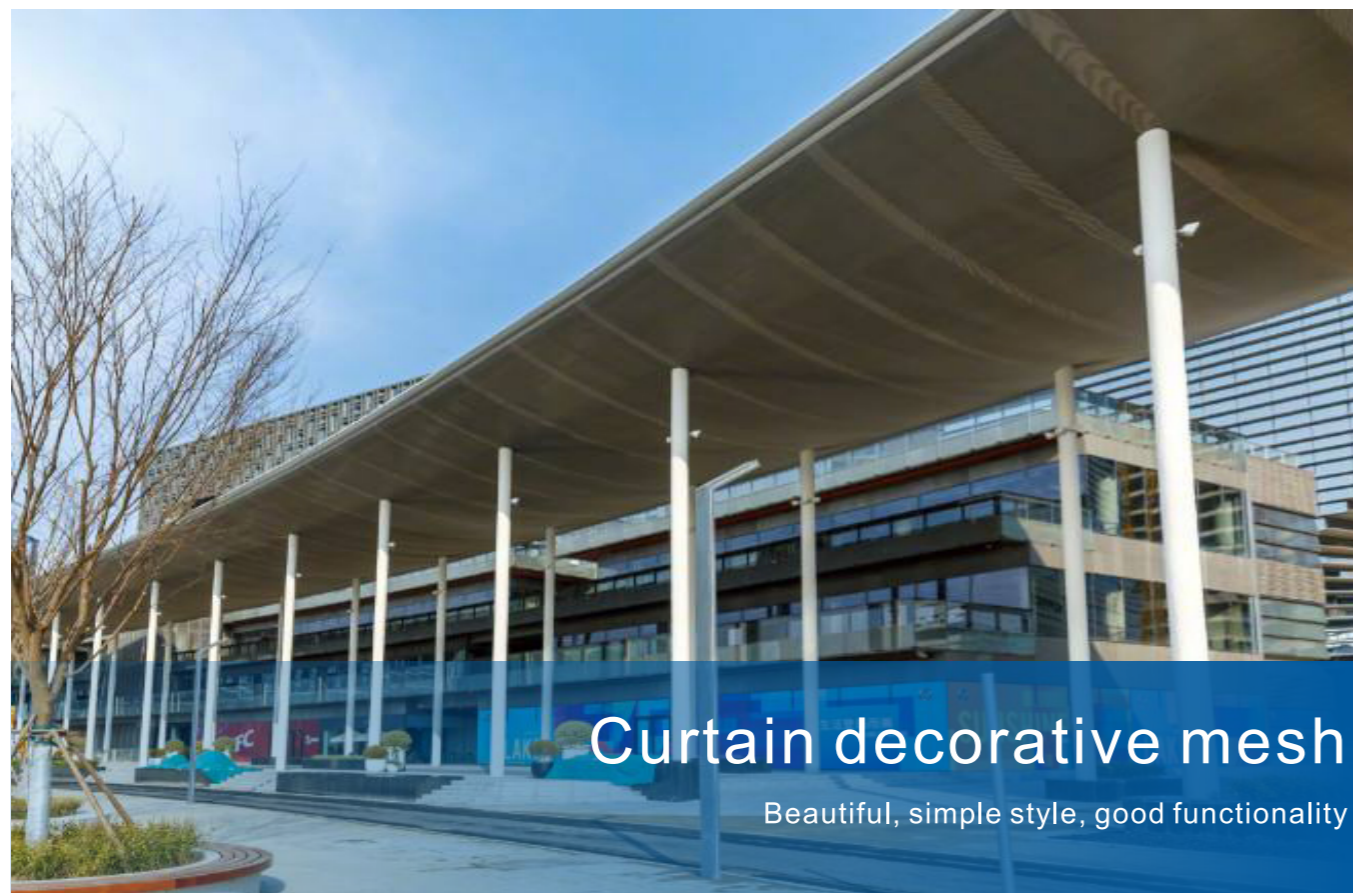

Curtain decorative mesh

Beautiful, simple style, good functionality

Product Parameters

Product Name: Curtain decorative mesh

Product material: 304/316

Brand Name: KIN LONG

Surface treatment: Natural /other

Common specifications: customized according to customer requirements

Form One

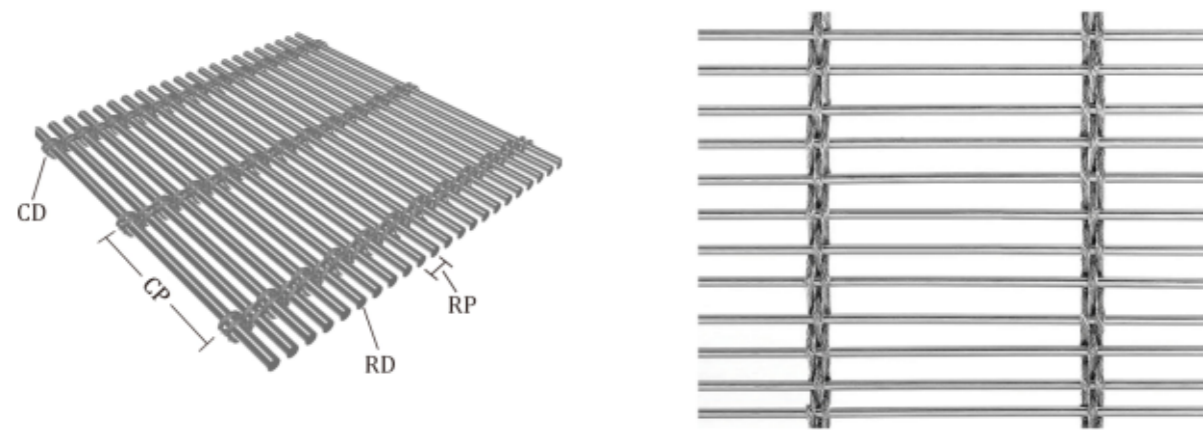

The material:304/316/316L CP:80MM CD:2mm*3 RD:3mm RP:10mm

Form two

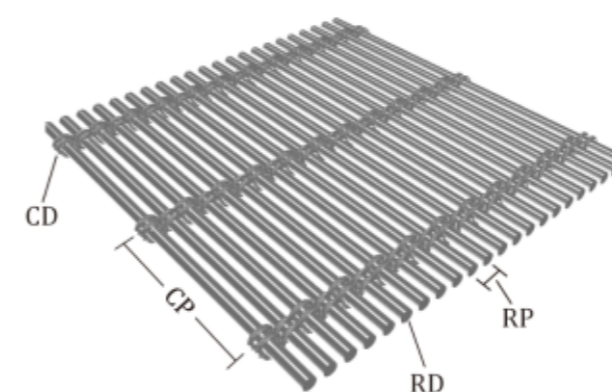

The material:304/316/316L CD:2mm*4 CP:80mm RD:3mm RP:6mm

Form Three

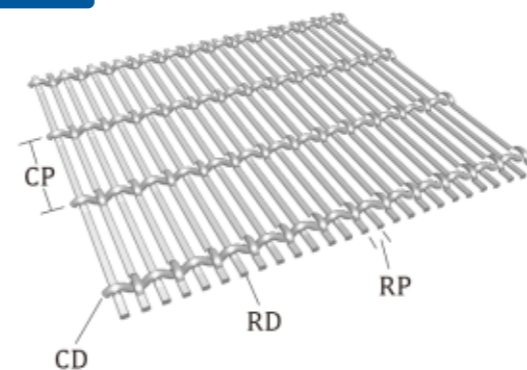

The material:304/316/316L CD:2mm*1 CP:17.5mm RD:1.5mm RP:3.5mm

Form four

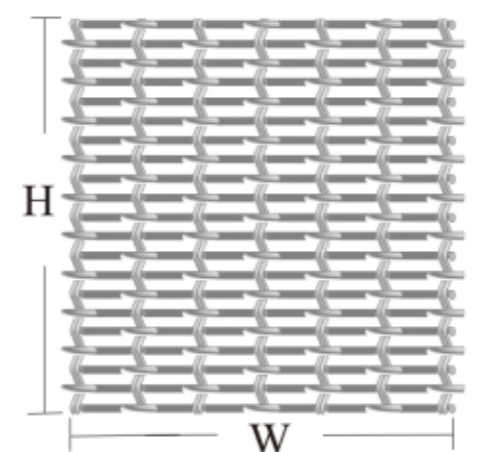

The material: :304/316/316L CD:1.2mm*2 CP:17.5mm RD:2mm RP:4mm

Installation Suggestion 1

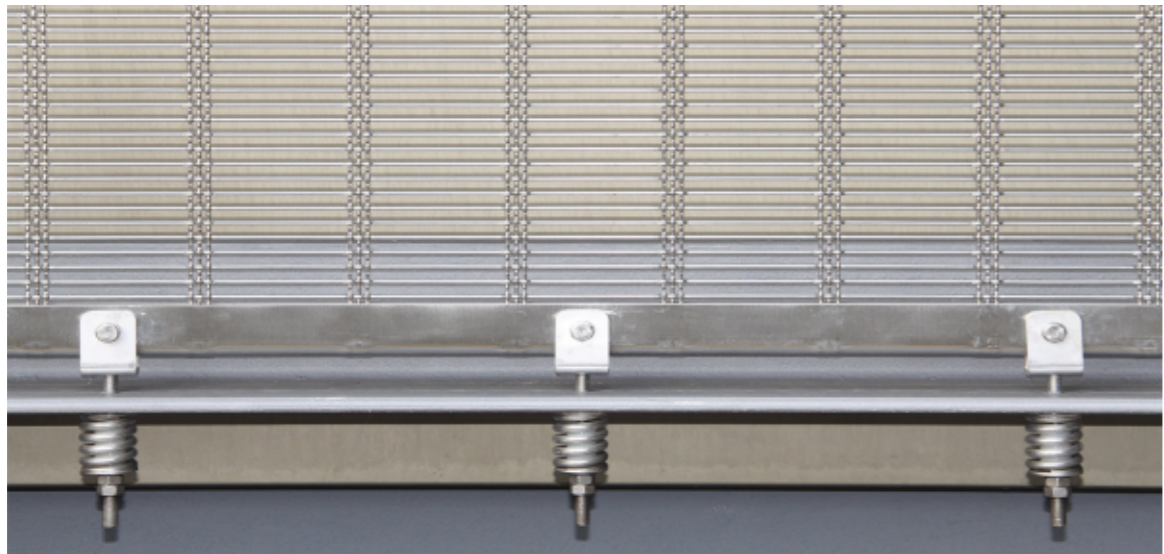
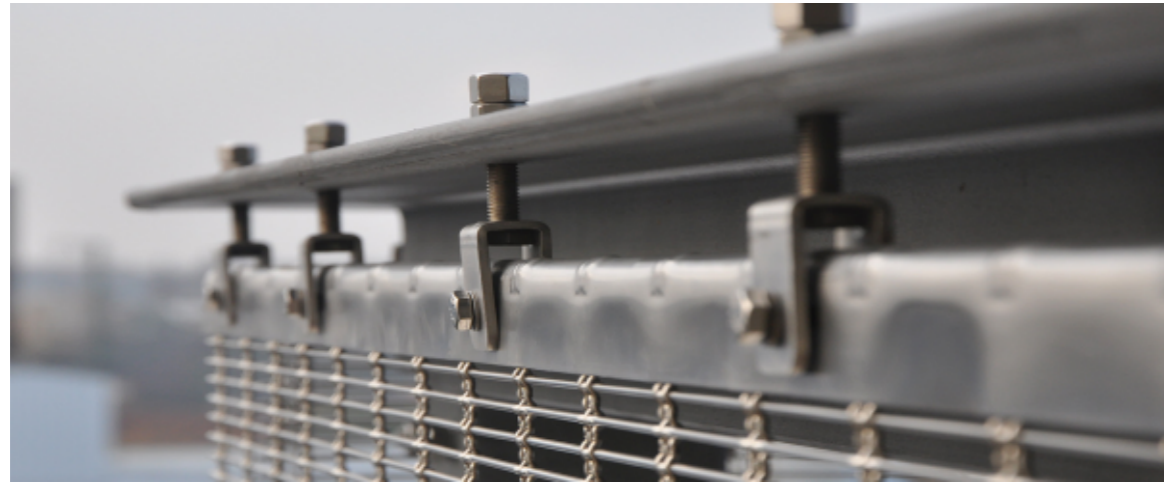

Installation Suggestion 2

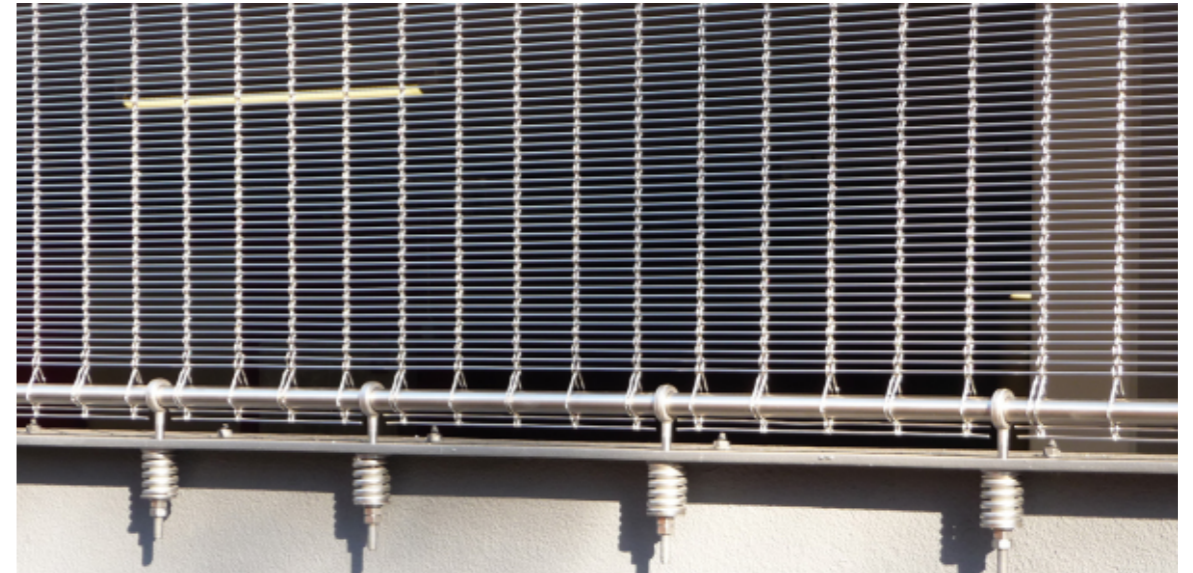
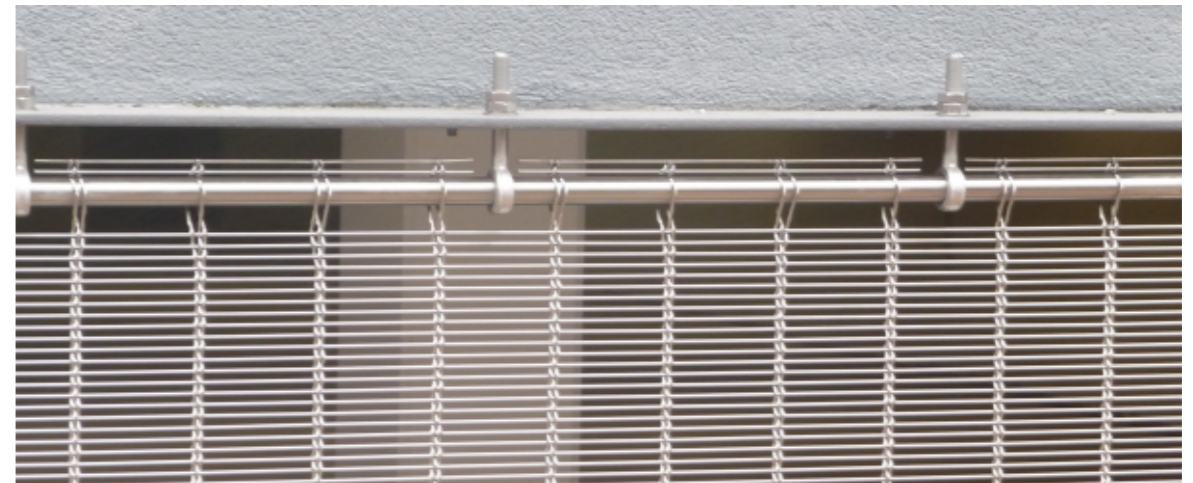



Spiral mesh

Simple and generous, personalized settings, simple installation

Product Parameters

Product Name: Spiral mesh

Product material: 304/316/201

Brand Name: KIN LONG

Surface treatment: Natural /other

Common specifications: customized according to customer requirements

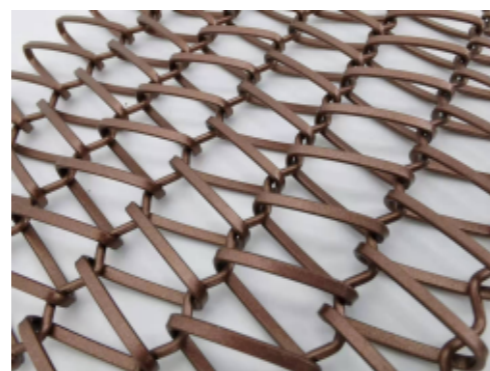
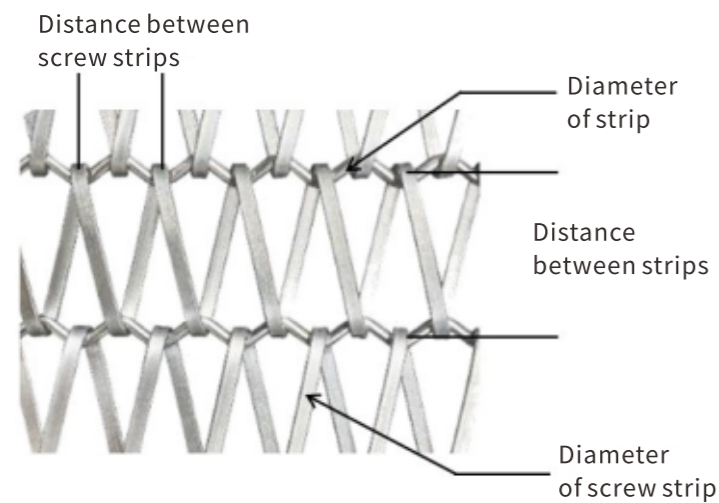

The material: 304/316/铝
Diameter of strip : 3mm

Diameter of screw strip: 1.2*5mm
Distance between strips: 60mm

Distance between screw strips: 7.5mm

Spiral net installation diagram

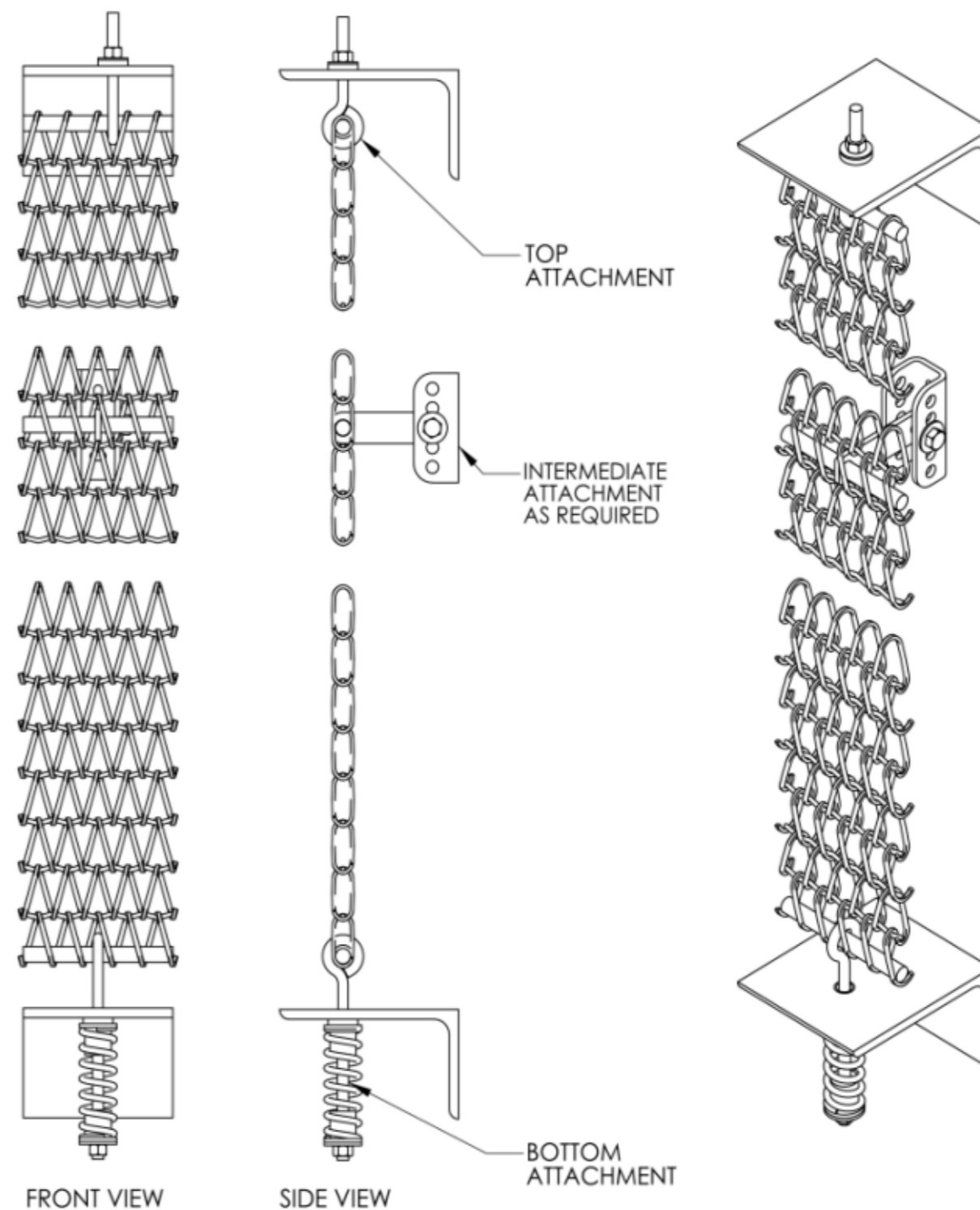



Curtain mesh

Simple and generous, personalized settings, simple installation

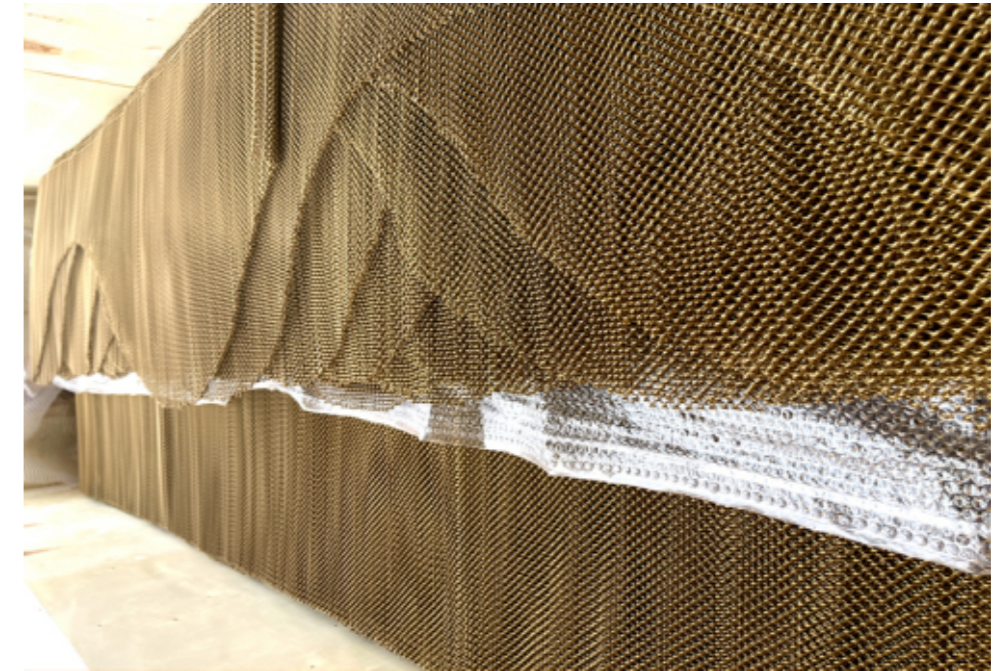

Product Features:
The installation is convenient and the decorative effect is vivid;
It has the flexibility of curtain and the luster of metal.

Product Parameters

Product Name: Curtain mesh

Product material: 304/316/ aluminum

Brand Name: KIN LONG

Surface treatment: natural color/titanium plating/spraying

Common specifications: customized according to customer requirements

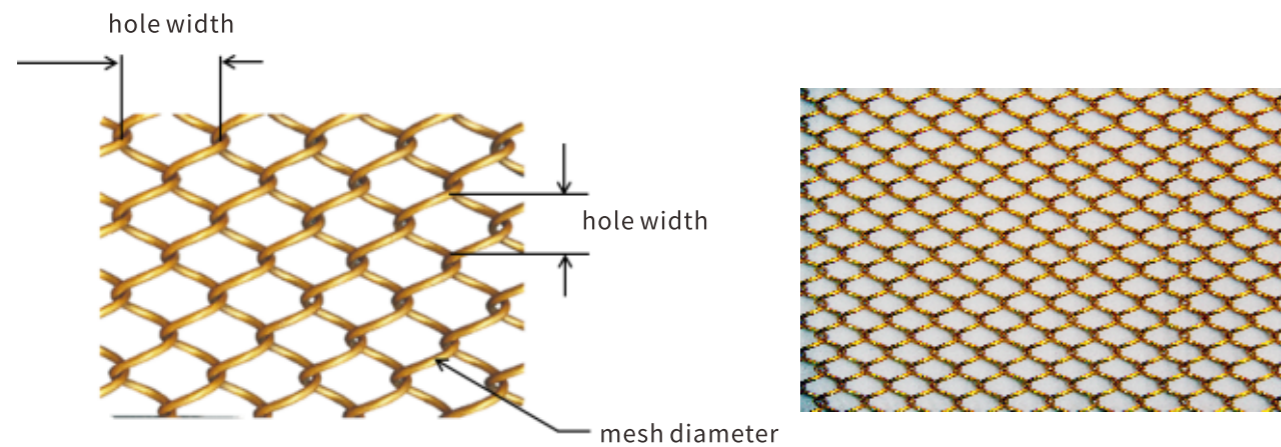

The material: 304/316/aluminum mesh diameter: 1.2mm hole width: 7.5mm hole height: 4mm



Scope of Application:
Architectural landscape, interior space, ceiling, background decoration, partition.



Stretched mesh

Various styles, exquisite, wide application

Product Parameters

Product Name: Stretched mesh

Product material: 304/316/ aluminum

Brand Name: KIN LONG

Mesh: diamond shape, scale shape

Color: natural, black oxide, fluorocarbon spray

Common specifications: Follow up customer requirements for customization

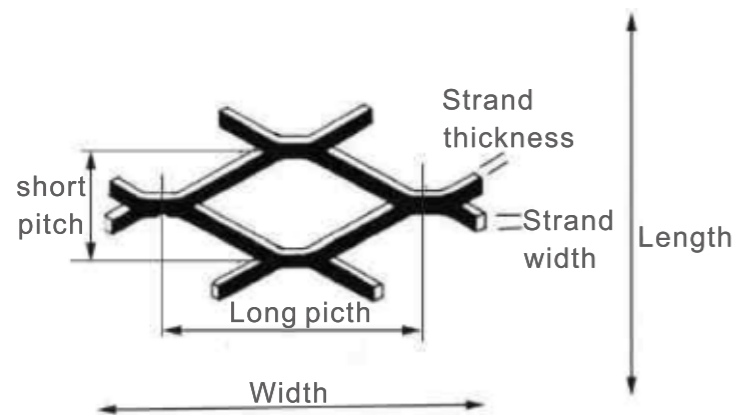

Mesh size: 1220*2440mm/1200*2400mm/1000*2000mm

Strand thickness: 5mm Strand width: 3mm Long pitch: 32mm Short pitch: 25mm

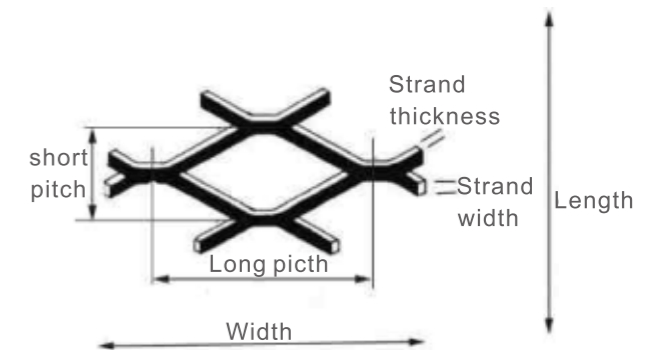
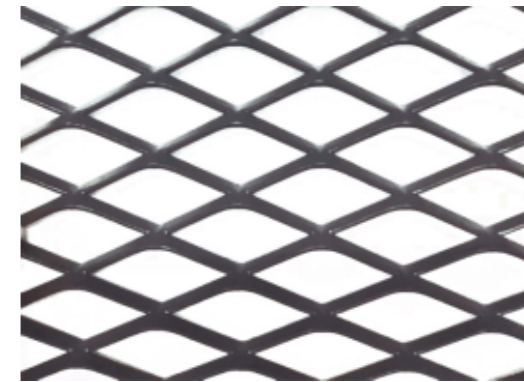

Mesh size: 1220*2440mm/1200*2400mm/1000*2000mm

Strand thickness: 2.5mm Strand width: 5mm Long pitch: 70mm Short pitch: 30mm

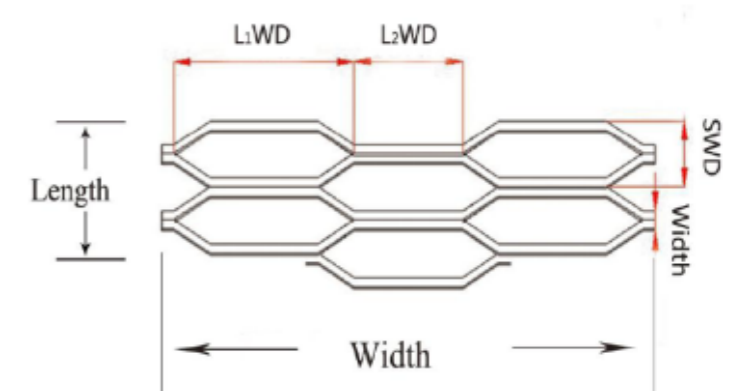
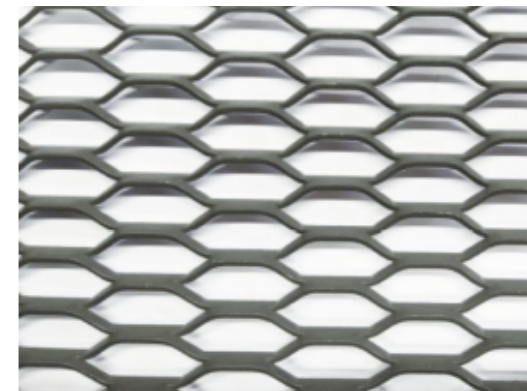

Mesh size: 1220*2440mm/1200*2400mm/1000*2000mm

Strand thickness: 3mm Width: 4mm L1WD: 28mm L2WD: 15mm SMD: 15mm

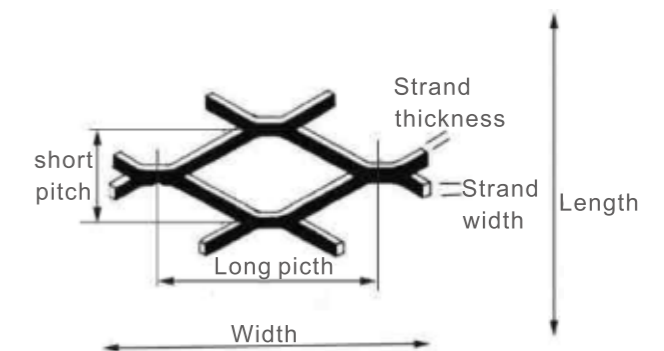
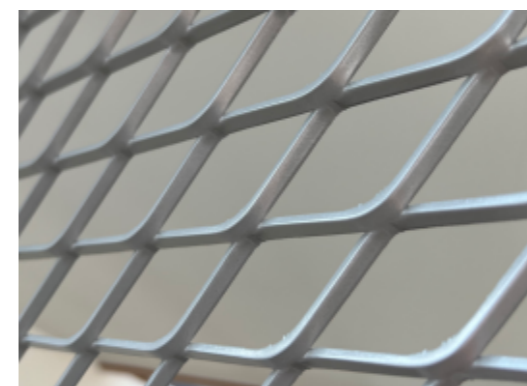

Mesh size: 1220*2440mm/1200*2400mm/1000*2000mm

Strand thickness: 2mm Strand width: 9.5mm Long pitch: 135mm Short pitch: 36.8mm

Installation Suggestion 1



Product Features::Various forms / Beautiful application

Installation Suggestion 2

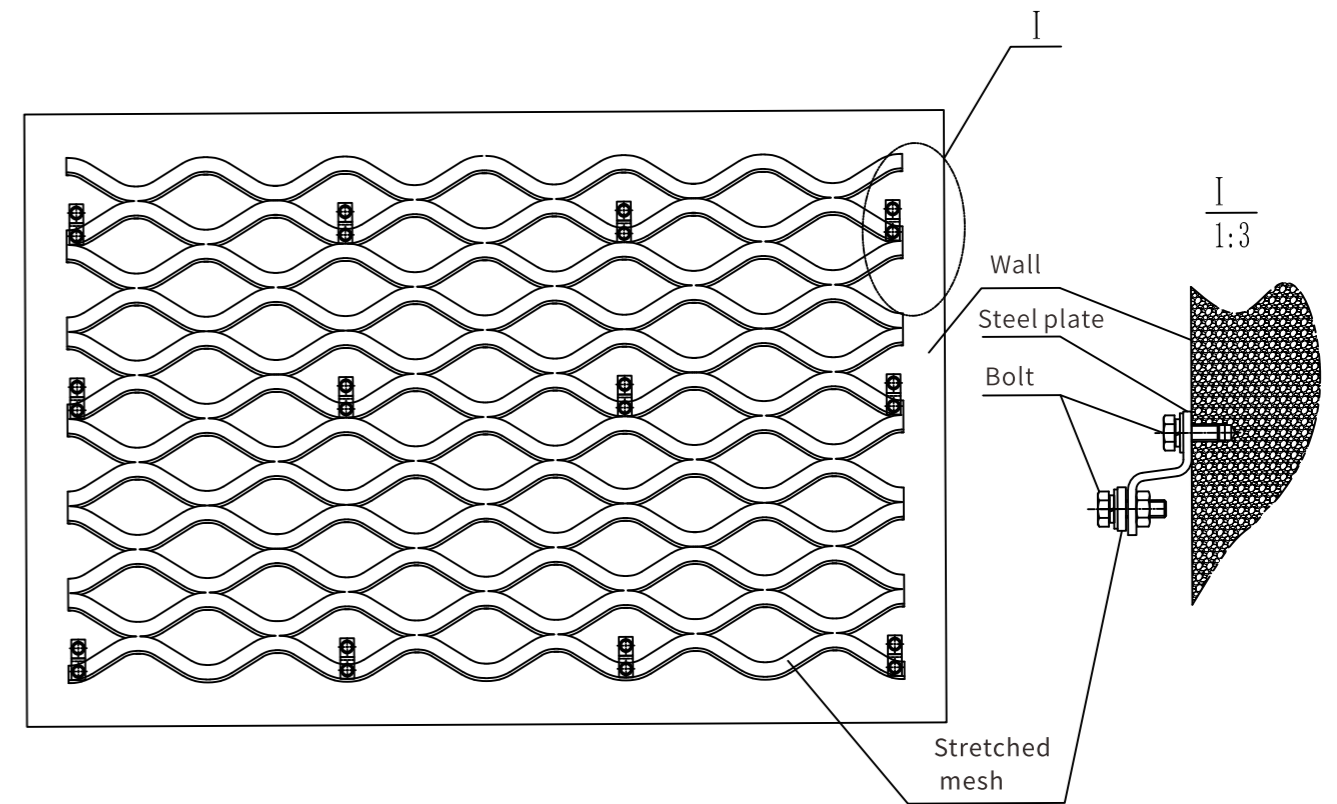

Scope of Application:: Road protection/Outdoor decoration/Protection against partition/Ceiling decoration



Welding mesh

Grid structure is simple, beautiful and practical, easy to transport

Product Parameters

Product Name: Welding mesh

Product material: 304/316/ carbon steel

Brand Name: KIN LONG

Surface treatment: natural color, galvanized, polished

Common specifications: customized according to customer requirements



Form One

The material: 304

The wire diameter: 4.8mm

Mesh size: 100*100mm

Surface treatment: electrolytic polishing

Application: curtain wall decoration

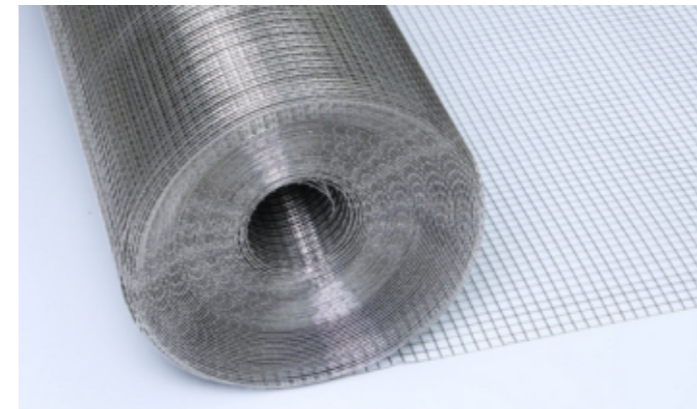

Form two

The material: carbon steel

The wire diameter: 0.6~1.5mm

Mesh size: 12.7*12.7mm

Surface treatment: Galvanized

Application: wall plastering/fence protection/
breeding and planting protection



Form Three

The material: 304

The wire diameter: 2.5mm

Mesh size: 20*20mm

Surface treatment: polishing

Application: Guardrail protection

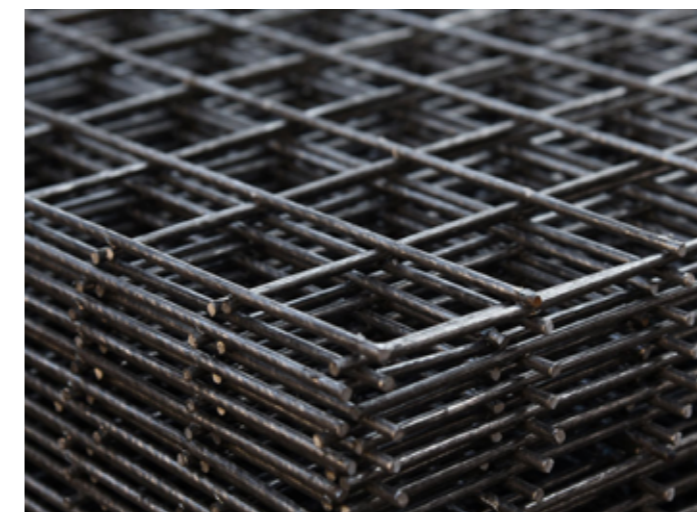

Form four

The material: Black wire

The wire diameter :3mm

Mesh size: 200*200mm

Surface treatment: natural color

Application: Floor heating mesh

Product Features: Welded, grid structure is simple, beautiful and practical/Long service life, durable
Scope of Application: Building wall/Exterior wall decoration/Guard rail protection/Road fence/Breeding/plantation

Other protective mesh

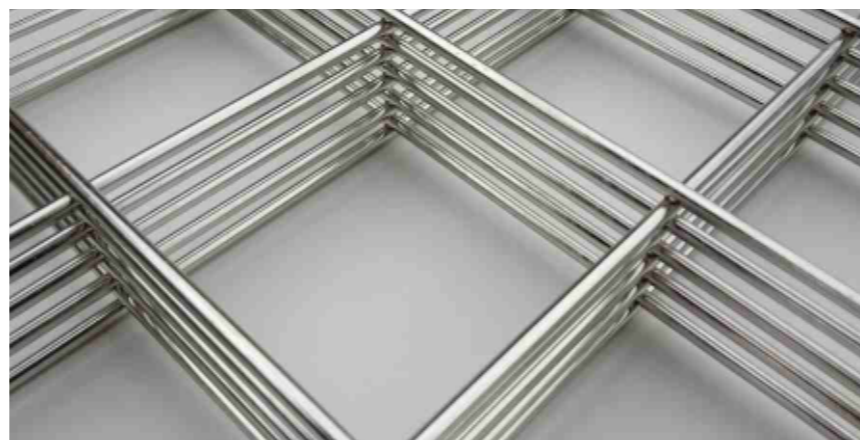
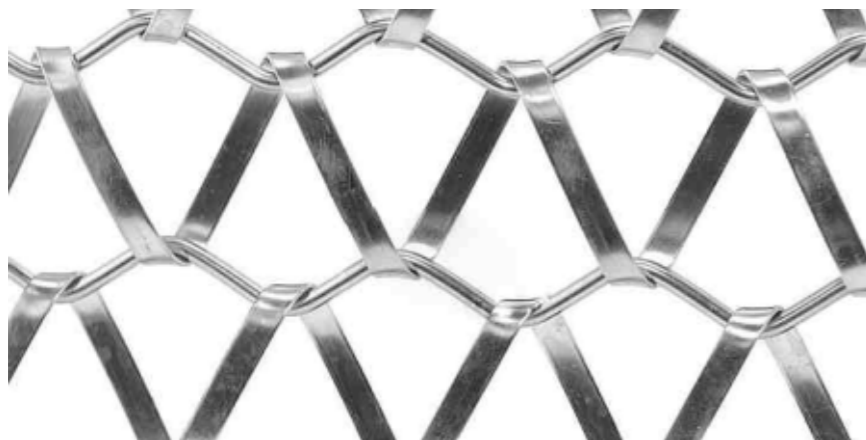
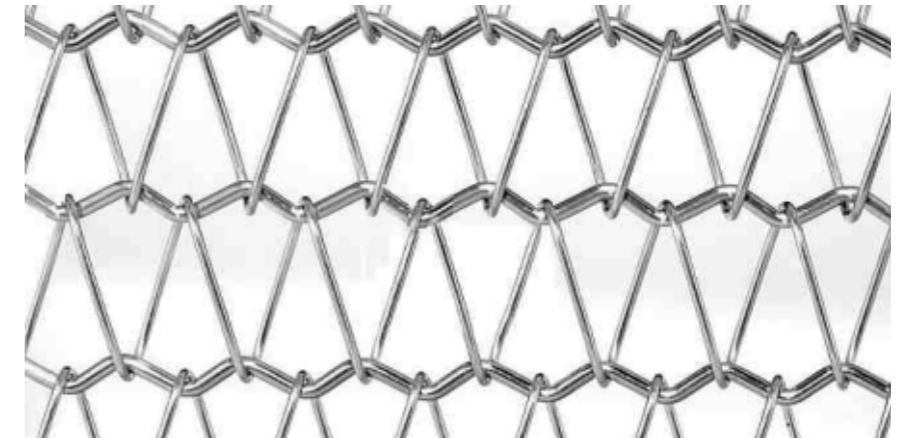
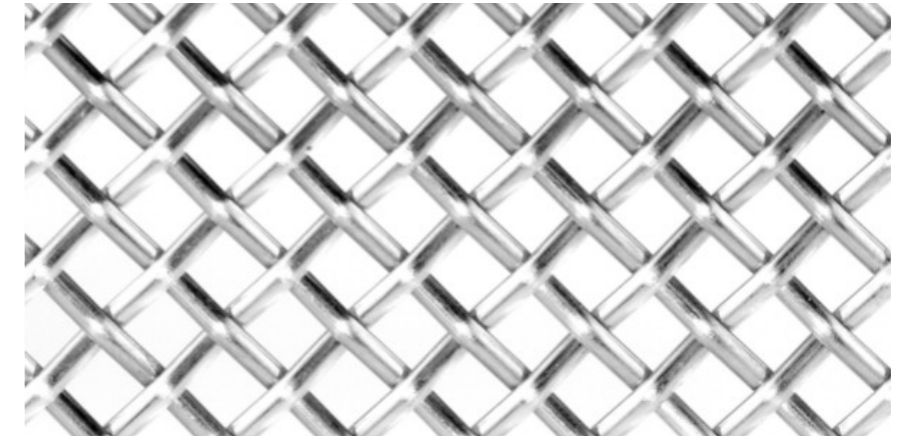
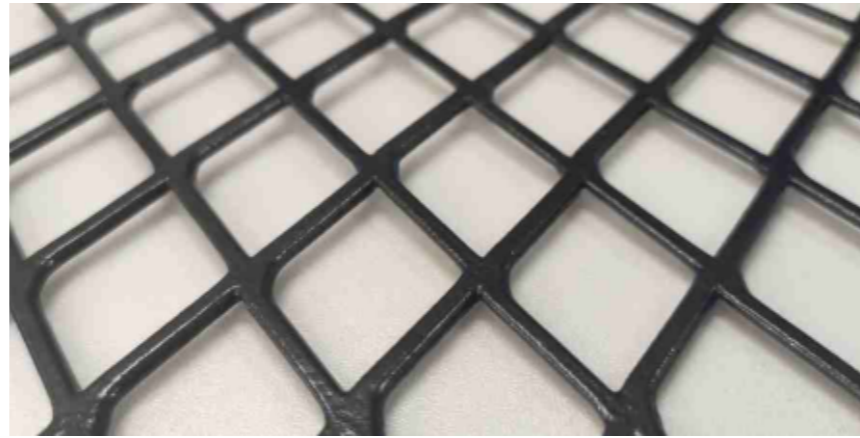
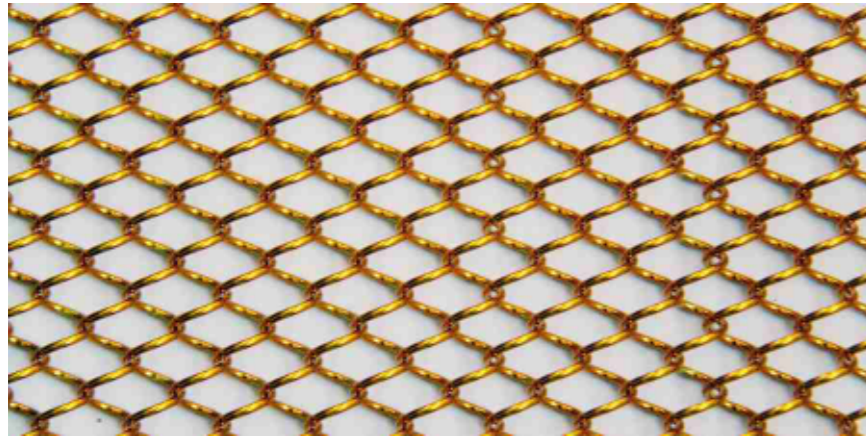

Other protective mesh